

STELRAD

SERIES



COMPACT
(Ireland)

50Δt
(75/65/20°C)

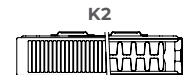
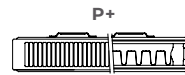
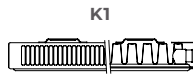

Height mm	Length mm	Sections	K1			P+			K2		
			Stelrad UIN	Watts	Btu/hr	Stelrad UIN	Watts	Btu/hr	Stelrad UIN	Watts	Btu/hr
300	400	12	143899	204	696	-	-	-	-	-	-
	500	15	143650	255	870	143656	373	1273	143662	491	1676
	1000	30	143651	509	1737	143657	745	2543	143663	982	3352
	1500	45	143652	764	2608	143658	1118	3816	143664	1473	5027
	2000	60	143653	1018	3474	143659	1490	5085	143665	1964	6703
	2500	75	143654	1273	4345	143660	1863	6358	143666	2455	8379
	3000	90	143655	1527	5212	143661	2235	7628	143667	2946	10055
500 Sizes only available to Ireland	400	12	143869	333	1137	-	-	-	143894	597	2039
	500	15	143870	416	1421	-	-	-	143882	747	2549
	600	18	143871	500	1705	-	-	-	143883	896	3059
	700	21	143872	583	1990	-	-	-	143884	1045	3568
	800	24	143873	666	2274	-	-	-	143885	1195	4078
	900	27	143874	749	2558	-	-	-	143886	1344	4588
	1000	30	143875	833	2842	-	-	-	143887	1494	5098
	1100	33	143876	916	3126	-	-	-	143888	1643	5607
	1200	36	143877	999	3411	-	-	-	143889	1792	6117
	1400	42	143878	1166	3979	-	-	-	143890	2091	7137
	1600	48	143879	1332	4548	-	-	-	143891	2390	8156
	1800	54	143880	1499	5116	-	-	-	143892	2688	9176
	2000	60	143881	1666	5684	-	-	-	143893	2987	10195
600	300	9	143646	294	1003	-	-	-	143647	520	1774
	400	12	143746	392	1338	143764	538	1836	143782	693	2365
	500	15	143747	490	1672	143765	673	2297	143783	866	2956
	600	18	143748	588	2007	143766	807	2754	143784	1039	3546
	700	21	143749	686	2341	143767	942	3215	143785	1212	4137
	800	24	143750	784	2676	143768	1076	3672	143786	1386	4730
	900	27	143751	882	3010	143769	1211	4133	143787	1559	5321
	1000	30	143752	980	3345	143770	1345	4590	143788	1732	5911
	1100	33	143753	1078	3679	143771	1480	5051	143789	1905	6502
	1200	36	143754	1176	4014	143772	1614	5509	143790	2078	7092
	1400	42	143755	1372	4683	143773	1883	6427	143791	2425	8277
	1600	48	143756	1568	5352	143774	2152	7345	143792	2771	9457
	1800	54	143757	1764	6021	143775	2421	8263	143793	3118	10642
	2000	60	143758	1960	6689	143776	2690	9181	143794	3464	11823
	2200	66	143759	2156	7358	143777	2959	10099	143795	3810	13004
	2400	72	143760	2352	8027	143778	3228	11017	143796	4157	14188
	2600	78	143761	2548	8696	143779	3497	11935	143797	4503	15369
	2800	84	143762	2744	9365	143780	3766	12853	143798	4850	16553
3000	90	143763	2940	10034	143781	4035	13771	143799	5196	17734	
700	300	9	143648	335	1143	--	-	-	143649	588	2006
	400	12	143812	447	1526	143830	612	2089	143848	784	2676
	500	15	143813	559	1908	143831	765	2611	143849	981	3348
	600	18	143814	670	2287	143832	918	3133	143850	1177	4017
	700	21	143815	782	2669	143833	1071	3655	143851	1373	4686
	800	24	143816	894	3051	143834	1224	4178	143852	1569	5355
	900	27	143817	1005	3430	143835	1377	4700	143853	1765	6024
	1000	30	143818	1117	3812	143836	1530	5222	143854	1961	6693
	1100	33	143819	1229	4195	143837	1683	5744	143855	2157	7362
	1200	36	143820	1340	4573	143838	1836	6266	143856	2353	8031
	1400	42	143821	1564	5338	143839	2142	7311	143857	2745	9369
	1600	48	143822	1787	6099	143840	2448	8355	143858	3138	10710
	1800	54	143823	2011	6864	143841	2754	9399	143859	3530	12048
	2000	60	143824	2234	7625	143842	3060	10444	143860	3922	13386
	2200	66	143825	2457	8386	143843	3366	11488	143861	4314	14724
	2400	72	143826	2681	9150	143844	3672	12533	143862	4706	16062
2600	78	143827	2904	9911	143845	3978	13577	143863	5099	17403	
2800	84	143828	3128	10676	143846	4284	14621	143864	5491	18741	
3000	90	143829	3351	11437	143847	4590	15666	143865	5883	20079	
900	400	9	3091104	544	1856	-	-	-	3092204	958	3269
	500	12	3091105	680	2320	-	-	-	3092205	1198	4088
	600	15	3091106	816	2784	-	-	-	3092206	1437	4903
	700	18	3091107	952	3248	-	-	-	3092207	1677	5722
	800	21	3091108	1088	3712	-	-	-	3092208	1916	6537
	900	24	3091109	1224	4176	-	-	-	3092209	2156	7356
	1000	27	3091110	1360	4640	-	-	-	3092210	2395	8172

At50 is the UK's industry standard for heating outputs, which has an operating temperature of 75/65/20°C.

40Δt
(65/55/20°C)

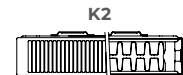
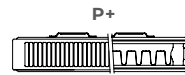
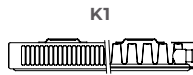

Height mm	Length mm	Sections	K1			P+			K2		
			Stelrad UIN	Watts	Btu/hr	Stelrad UIN	Watts	Btu/hr	Stelrad UIN	Watts	Btu/hr
300	400	12	143899	153	521	-	-	-	-	-	-
	500	15	143650	191	651	143656	279	952	143662	367	1253
	1000	30	143651	381	1299	143657	557	1902	143663	735	2507
	1500	45	143652	571	1950	143658	836	2854	143664	1102	3760
	2000	60	143653	761	2599	143659	1115	3804	143665	1469	5014
	2500	75	143654	952	3250	143660	1394	4756	143666	1836	6267
	3000	90	143655	1142	3898	143661	1672	5706	143667	2204	7521
500 Sizes only available to Ireland	400	12	143869	249	850	-	-	-	143894	447	1525
	500	15	143870	311	1063	-	-	-	143882	559	1906
	600	18	143871	374	1276	-	-	-	143883	670	2288
	700	21	143872	436	1488	-	-	-	143884	782	2669
	800	24	143873	498	1701	-	-	-	143885	894	3050
	900	27	143874	561	1913	-	-	-	143886	1005	3432
	1000	30	143875	623	2126	-	-	-	143887	1117	3813
	1100	33	143876	685	2339	-	-	-	143888	1229	4194
	1200	36	143877	747	2551	-	-	-	143889	1341	4576
	1400	42	143878	872	2976	-	-	-	143890	1564	5338
	1600	48	143879	997	3402	-	-	-	143891	1787	6101
	1800	54	143880	1121	3827	-	-	-	143892	2011	6863
	2000	60	143881	1246	4252	-	-	-	143893	2234	7626
600	300	9	143646	220	750	-	-	-	143647	1229	4194
	400	12	143746	293	1001	143764	402	1373	143782	1341	4576
	500	15	143747	367	1251	143765	503	1718	143783	1564	5338
	600	18	143748	440	1501	143766	604	2060	143784	1787	6101
	700	21	143749	513	1751	143767	705	2405	143785	2011	6863
	800	24	143750	586	2001	143768	805	2747	143786	2234	7626
	900	27	143751	660	2252	143769	906	3092	143787	1166	3980
	1000	30	143752	733	2502	143770	1006	3434	143788	1296	4422
	1100	33	143753	806	2752	143771	1107	3778	143789	1425	4863
	1200	36	143754	880	3002	143772	1207	4120	143790	1554	5305
	1400	42	143755	1026	3503	143773	1408	4807	143791	1814	6191
	1600	48	143756	1173	4003	143774	1610	5494	143792	2073	7074
	1800	54	143757	1319	4503	143775	1811	6181	143793	2332	7960
	2000	60	143758	1466	5004	143776	2012	6867	143794	2591	8843
	2200	66	143759	1613	5504	143777	2213	7554	143795	2850	9727
	2400	72	143760	1759	6004	143778	2415	8241	143796	3109	10613
2600	78	143761	1906	6505	143779	2616	8928	143797	3368	11496	
2800	84	143762	2053	7005	143780	2817	9614	143798	3628	12382	
3000	90	143763	2199	7506	143781	3018	10301	143799	3887	13265	
700	300	9	143648	251	855	-	-	-	143649	440	1500
	400	12	143812	334	1141	143830	458	1562	143848	586	2001
	500	15	143813	418	1427	143831	572	1953	143849	734	2504
	600	18	143814	501	1710	143832	687	2344	143850	880	3005
	700	21	143815	585	1996	143833	801	2734	143851	1027	3505
	800	24	143816	669	2282	143834	916	3125	143852	1174	4006
	900	27	143817	752	2566	143835	1030	3515	143853	1320	4506
	1000	30	143818	836	2852	143836	1144	3906	143854	1467	5006
	1100	33	143819	919	3138	143837	1259	4297	143855	1613	5507
	1200	36	143820	1002	3421	143838	1373	4687	143856	1760	6007
	1400	42	143821	1170	3993	143839	1602	5468	143857	2053	7008
	1600	48	143822	1337	4562	143840	1831	6250	143858	2347	8011
	1800	54	143823	1504	5134	143841	2060	7031	143859	2640	9012
	2000	60	143824	1671	5703	143842	2289	7812	143860	2934	10013
	2200	66	143825	1838	6273	143843	2518	8593	143861	3227	11013
	2400	72	143826	2005	6844	143844	2747	9374	143862	3520	12014
2600	78	143827	2172	7414	143845	2976	10156	143863	3814	13017	
2800	84	143828	2340	7986	143846	3204	10937	143864	4107	14018	
3000	90	143829	2507	8555	143847	3433	11718	143865	4400	15019	
900	400	9	3091104	407	1388	-	-	-	3092204	717	2445
	500	12	3091105	509	1735	-	-	-	3092205	896	3058
	600	15	3091106	610	2083	-	-	-	3092206	1075	3667
	700	18	3091107	712	2430	-	-	-	3092207	1254	4280
	800	21	3091108	814	2777	-	-	-	3092208	1433	4890
	900	24	3091109	916	3124	-	-	-	3092209	1613	5502
	1000	27	3091110	1017	3471	-	-	-	3092210	1791	6112

30Δt
(55/45/20°C)

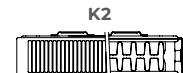
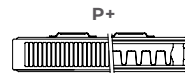

Height mm	Length mm	Sections	K1			P+			K2		
			Stelrad UIN	Watts	Heat output Btu/hr	Stelrad UIN	Watts	Heat output Btu/hr	Stelrad UIN	Watts	Heat output Btu/hr
300	400	12	143899	105	358	-	-	-	-	-	-
	500	15	143650	131	448	143656	192	656	143662	253	863
	1000	30	143651	262	895	143657	384	1309	143663	506	1726
	1500	45	143652	393	1343	143658	576	1965	143664	759	2589
	2000	60	143653	524	1789	143659	767	2619	143665	1011	3452
	2500	75	143654	656	2238	143660	959	3275	143666	1264	4315
	3000	90	143655	786	2684	143661	1151	3928	143667	1517	5178
500 Sizes only available to Ireland	400	12	143869	172	585	-	-	-	143894	308	1050
	500	15	143870	214	732	-	-	-	143882	385	1313
	600	18	143871	257	878	-	-	-	143883	462	1575
	700	21	143872	300	1025	-	-	-	143884	538	1838
	800	24	143873	343	1171	-	-	-	143885	615	2100
	900	27	143874	386	1317	-	-	-	143886	692	2363
	1000	30	143875	429	1464	-	-	-	143887	769	2625
	1100	33	143876	472	1610	-	-	-	143888	846	2888
	1200	36	143877	515	1756	-	-	-	143889	923	3150
	1400	42	143878	600	2049	-	-	-	143890	1077	3675
	1600	48	143879	686	2342	-	-	-	143891	1231	4200
	1800	54	143880	772	2635	-	-	-	143892	1385	4725
	2000	60	143881	858	2927	-	-	-	143893	1538	5250
600	300	9	143646	151	517	-	-	-	143647	268	914
	400	12	143746	202	689	143764	277	946	143782	357	1218
	500	15	143747	252	861	143765	347	1183	143783	446	1522
	600	18	143748	303	1034	143766	416	1418	143784	535	1826
	700	21	143749	353	1206	143767	485	1656	143785	624	2130
	800	24	143750	404	1378	143768	554	1891	143786	714	2436
	900	27	143751	454	1550	143769	624	2129	143787	803	2740
	1000	30	143752	505	1723	143770	693	2364	143788	892	3044
	1100	33	143753	555	1895	143771	762	2601	143789	981	3348
	1200	36	143754	606	2067	143772	831	2837	143790	1070	3652
	1400	42	143755	707	2412	143773	970	3310	143791	1249	4262
	1600	48	143756	808	2756	143774	1108	3783	143792	1427	4871
	1800	54	143757	908	3101	143775	1247	4255	143793	1606	5480
	2000	60	143758	1009	3445	143776	1385	4728	143794	1784	6089
	2200	66	143759	1110	3790	143777	1524	5201	143795	1962	6697
	2400	72	143760	1211	4134	143778	1662	5674	143796	2141	7307
2600	78	143761	1312	4479	143779	1801	6147	143797	2319	7915	
2800	84	143762	1413	4823	143780	1939	6619	143798	2498	8525	
3000	90	143763	1514	5168	143781	2078	7092	143799	2676	9133	
700	300	9	143648	173	589	-	-	-	143649	303	1033
	400	12	143812	230	786	143830	315	1076	143848	404	1378
	500	15	143813	288	983	143831	394	1345	143849	505	1724
	600	18	143814	345	1178	143832	473	1614	143850	606	2069
	700	21	143815	403	1375	143833	552	1882	143851	707	2413
	800	24	143816	460	1571	143834	630	2151	143852	808	2758
	900	27	143817	518	1766	143835	709	2420	143853	909	3102
	1000	30	143818	575	1963	143836	788	2689	143854	1010	3447
	1100	33	143819	633	2160	143837	867	2958	143855	1111	3791
	1200	36	143820	690	2355	143838	946	3227	143856	1212	4136
	1400	42	143821	805	2749	143839	1103	3765	143857	1414	4825
	1600	48	143822	920	3141	143840	1261	4303	143858	1616	5516
	1800	54	143823	1036	3535	143841	1418	4841	143859	1818	6205
	2000	60	143824	1151	3927	143842	1576	5379	143860	2020	6894
	2200	66	143825	1265	4319	143843	1733	5916	143861	2222	7583
	2400	72	143826	1381	4712	143844	1891	6454	143862	2424	8272
2600	78	143827	1496	5104	143845	2049	6992	143863	2626	8962	
2800	84	143828	1611	5498	143846	2206	7530	143864	2828	9652	
3000	90	143829	1726	5890	143847	2364	8068	143865	3030	10341	
900	400	9	3091104	280	956	-	-	-	3092204	493	1683
	500	12	3091105	350	1195	-	-	-	3092205	617	2105
	600	15	3091106	420	1434	-	-	-	3092206	740	2525
	700	18	3091107	490	1673	-	-	-	3092207	864	2947
	800	21	3091108	560	1912	-	-	-	3092208	987	3367
	900	24	3091109	630	2151	-	-	-	3092209	1110	3788
1000	27	3091110	700	2390	-	-	-	3092210	1233	4208	

WALL MOUNTING INFORMATION

All dimensions in mm. Inches in brackets.

Floor mounting brackets available.

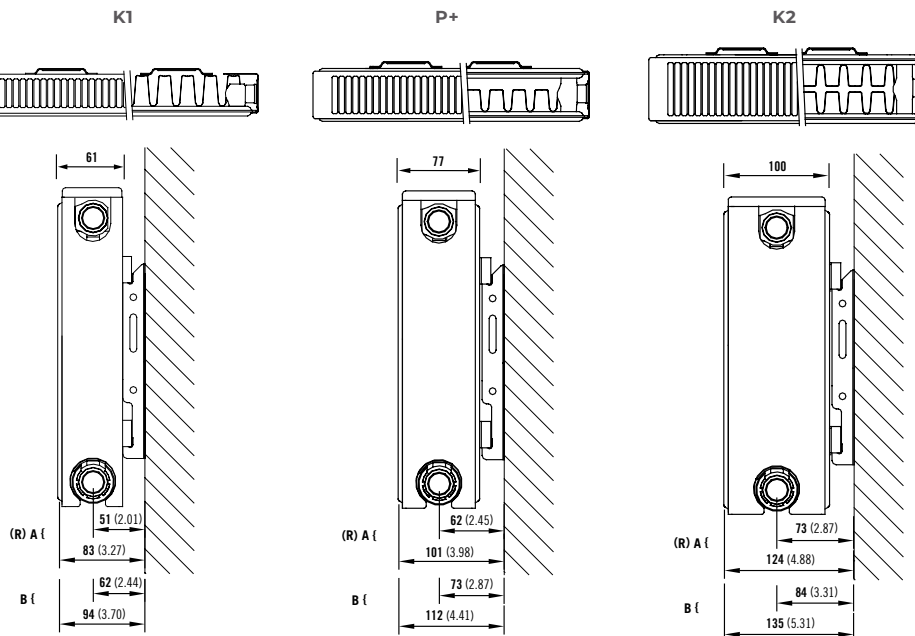

BRACKET POSITION

A = Closest to wall B = Furthest from wall (R) = Recommended mounting position.

COMPACT MOUNTING BRACKETS

All dimensions in mm. Inches in brackets. Floor mounting brackets available.

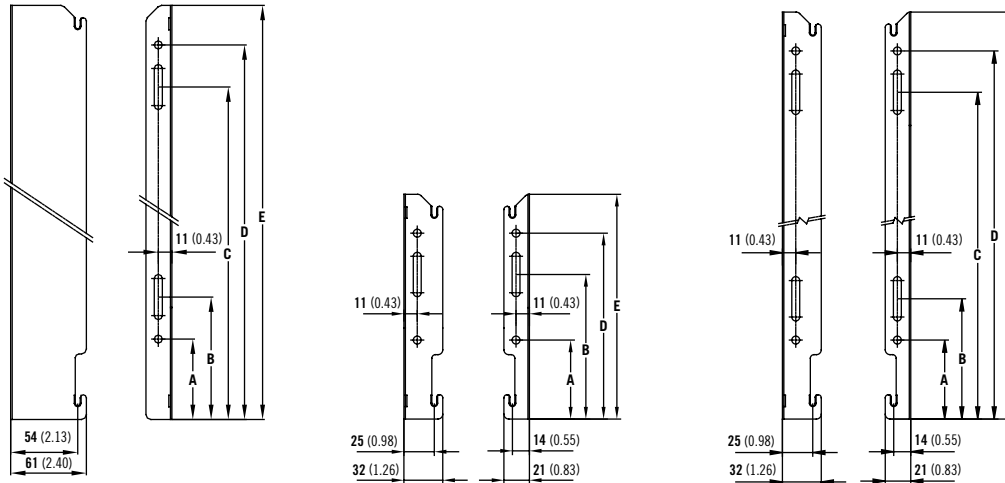

Dimensions	mm	inches	mm	inches	mm	inches	mm	inches	mm	inches
Height	300	11.81	500	17.72	600	23.62	700	27.56	900	35.43
A	65	2.56	65	2.56	65	2.56	65	2.56	65	2.56
B	119	4.69	99	3.90	99	3.90	99	3.90	99	3.90
C	-	-	269	10.59	419	16.50	519	20.43	719	28.31
D	153	6.02	303	11.93	453	17.83	553	21.77	753	29.65
E	185	7.28	335	13.19	485	19.09	585	23.03	785	30.91

K1, P+ AND K2 LUG POSITIONS

All dimensions in mm. Inches in brackets.

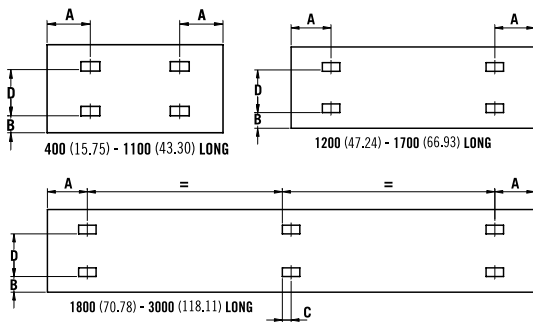

P+ & K2

Dimensions	mm	in
A	133	5.24
B	60	2.36

K1

Dimensions	mm	in
A 400mm	117	4.61
A 500 - 3000mm	150	5.91
B 400 - 3000mm	60	2.36
C 1800 - 3000mm	17	0.67

PANEL HEIGHT

D		D	
mm	in	mm	in
300	11.81	153	6.02
500	17.72	303	11.93
600	23.62	453	17.83
700	27.56	553	21.77
900	35.43	753	29.65

CONNECTIONS

Each radiator comes with ½" inlet connections as standard.

PIPING OPTIONS

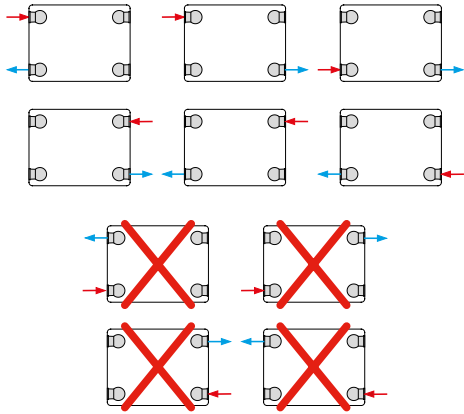

EN 442 CERTIFICATION DATA - CETIAT TESTED IN ACCORDANCE WITH BS EN 442

Type	K1					P+			K2				
Height	300	500	600	700	900	300	600	700	300	500	600	700	900
W/m at 75/65/20	509	833	980	1117	1360	745	1345	1530	982	1494	1732	1961	2395
n-coefficients	1.32	1.31	1.30	1.29	1.29	1.33	1.34	1.34	1.33	1.33	1.33	1.34	1.34
Heated surface area (m ² /m)	2.09	3.37	3.80	5.51	7.22	2.44	5.24	6.18	3.51	6.33	7.74	9.15	11.97
Weight (kg/m)	9.31	14.51	16.24	22.90	29.30	14.29	29.80	34.50	16.80	29.93	35.00	40.53	51.60
Water contents (l/m)	1.89	2.57	2.80	3.77	4.80	3.70	6.60	7.63	3.70	5.63	6.60	7.63	9.70
Wall to tap centre (mm)	51	51	51	51	51	62	62	62	73	73	73	73	73

PRESSURE DROPS

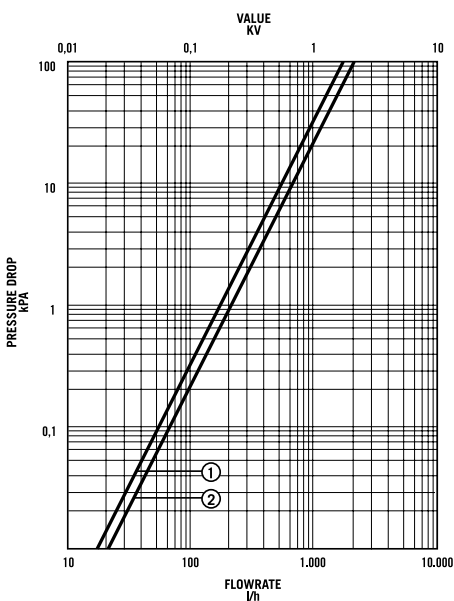

- ① Type 10 (P1), 11 (K1)
- ② Type 21 (P+), 22 (K2)