



**Stelrad**<sup>®</sup>

Aqua Series

*Kitchen & Bathroom  
Collection*

*There's a reason Stelrad are the UK's  
number one radiator brand*

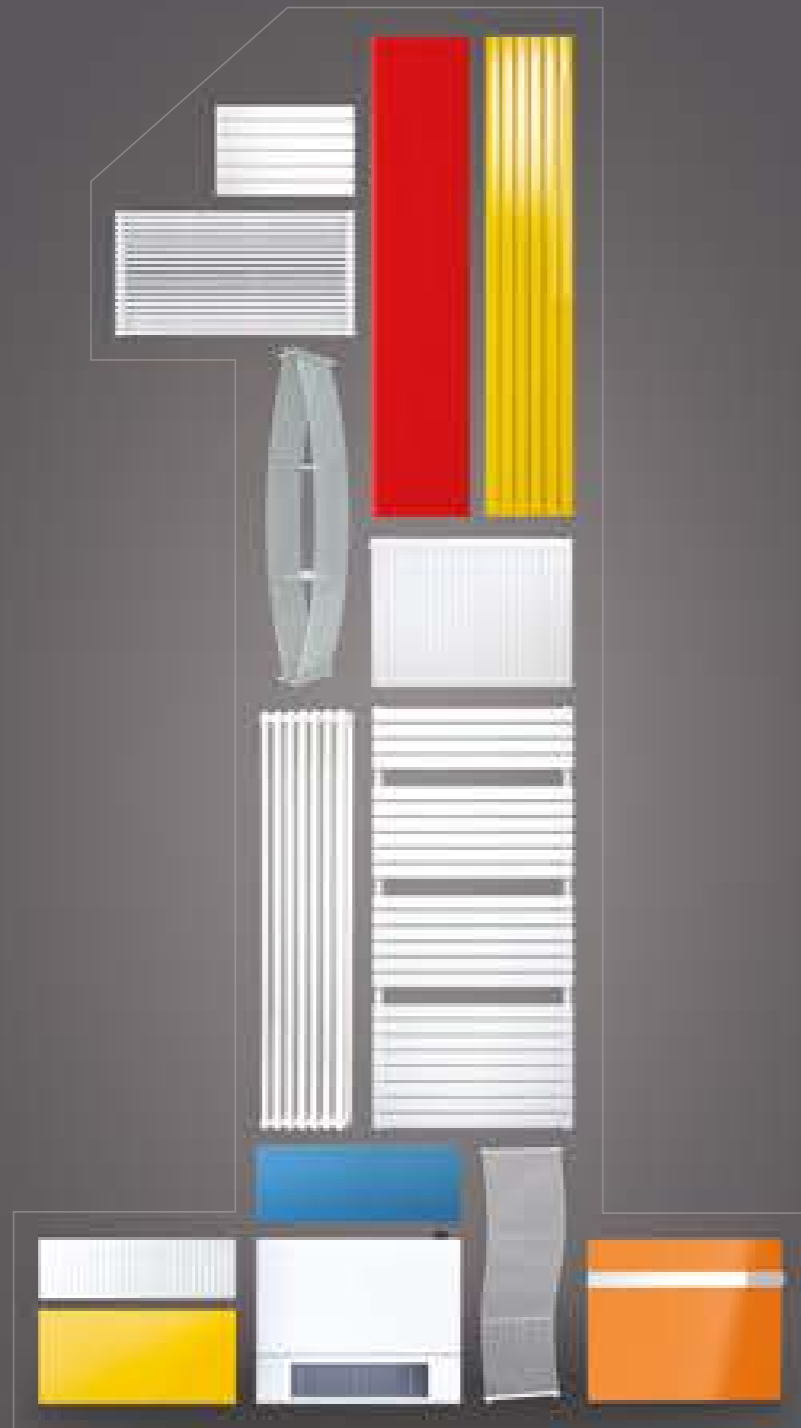

## *LEADING THE WAY*

Stelrad has been manufacturing high quality, steel radiators since 1936, so it's safe to say we know a thing or two about heating.

Since our beginnings, we've grown into the UK's number one radiator brand, manufacturing and distributing over 2 million radiators and products every year. With an expert research facility in Belgium, we're dedicated to continually developing innovative products and widening our extensive range to enable you to offer your customers the largest selection of technically-advanced radiator styles and sizes in the UK.



Caliente Rail



Slimline Towel Rail



Vistaline



Concord Rail



Ellipse



Esprit



Caliente Curved Rail

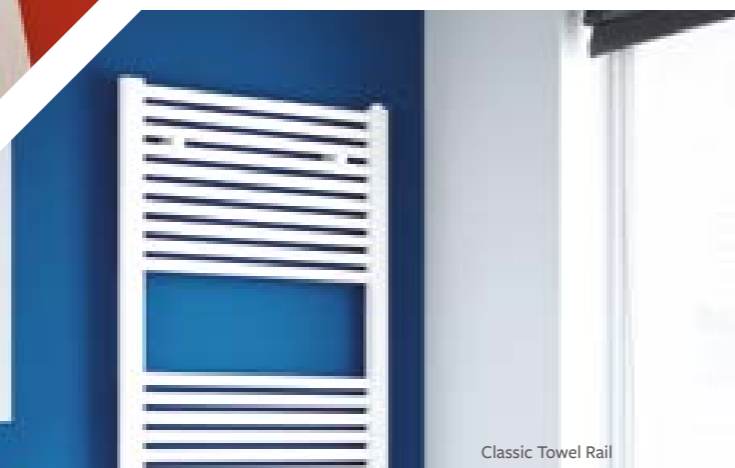

Classic Towel Rail



Vertical Ultra



Caliente Rail



Arc



## THINGS TO CONSIDER

Innovation, development and customer service is at the heart of everything we do, and we offer ranges of radiators to suit your every need. Energy saving, safety, designer style, kitchens, bathrooms - a huge choice, many available in 36 colours to match your taste and decor. Ordering is easy, and you can download simple fitting instructions and guides from our website. So when you're thinking about radiators, there's just one name to consider... Stelrad.

## PRODUCT RANGES

Discover our range of designer radiators, expertly designed and styled to suit every taste and interior. You can choose from a range of shapes, sizes, colours and finishes.

## COLOURS

These days you are not limited to a traditional white radiator, you have the freedom to choose the most suitable colour radiator which will complement the colour scheme of your room. Most of our radiators can be ordered in a choice of 36 colours and have up to an 8 week lead time.



## FITTING

Plumbers and installers are at the heart of everything we do. Our definitive range of products offer a solution for every project and requirement. View our helpful range of downloadable installation documents and videos at [Stelrad.com](http://Stelrad.com)

## QUOTE SERVICE

Our nationwide Specification and Quotes Teams are on hand to discuss your requirements for your project. Contact our expert Quotes Team for a personalised quote on 01709 572267 or email [stelrad.quotes@stelrad.com](mailto:stelrad.quotes@stelrad.com)

## ORDERING

If you would like to order a product, please visit [Stelrad.com](http://Stelrad.com) to find your nearest stocking branch.

## Aqua Series

### Decorative Collection

**NEW** Slimline Towel Rail

Classic Towel Rail

STR (Stelrad Towel Radiator)

Caliente Rail

Caliente Curved Rail

Concord Rail

Esprit

### Designer Collection

Vertical Ultra

Excel

Arc & Wave

Vistaline

Ellipse

Optia

## KITCHEN AND BATHROOM COLLECTION

A radiator shouldn't just be functional - it should also add aesthetic appeal to any room. Combining dependable performance with designer styling, our Aqua Series offers you the best of both worlds. Choose from our Decorative and Designer Collections and discover the perfect radiator for your unique kitchen or bathroom.

## DECORATIVE COLLECTION

Consisting of seven stylish yet cost-effective radiator designs, our Decorative Collection delivers variety and performance, at a streamlined price. From our 'Classic' option, which promises unbeatable value for money, to our elegant 'Esprit'. If you are seeking a dependable towel rail for your kitchen or bathroom, and need to keep a close eye on costs, look no further than this unique and appealing product collection.



DECORATIVE COLLECTION

# NEW SLIMLINE TOWEL RAIL

The Stelrad Slimline Towel Rail complements and completes the Aqua Series, with its chrome finish offering a slimline option at an affordable price.

RANGE	9
TYPES	Straight Chrome
HEIGHTS (MM)	650 - 1785
LENGTHS (MM)	400, 500, 600
OUTPUTS (WATTS)	174 - 614
OUTPUTS (BTU/HR)	594 - 2095
COLOURS	Chrome
WORKING PRESSURE	8 bar

Please refer to page 48 for technical information.

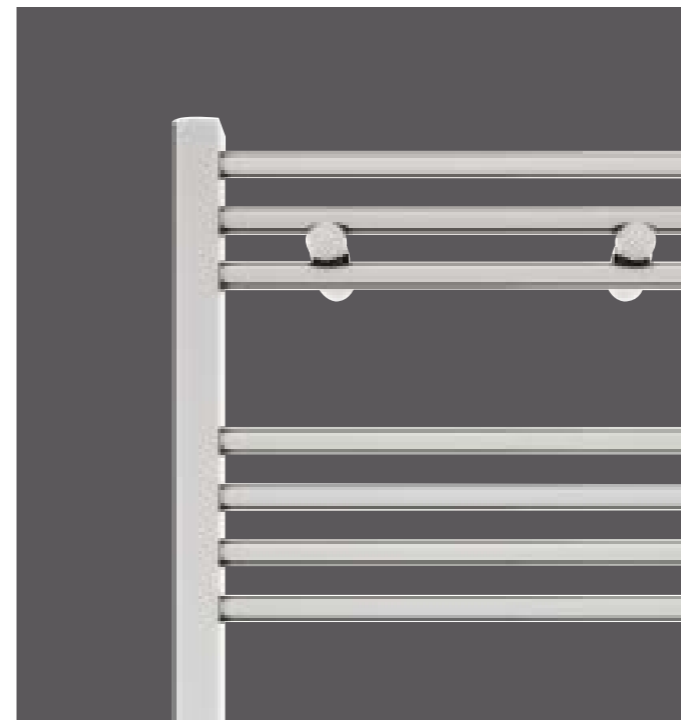



DECORATIVE COLLECTION

## CLASSIC TOWEL RAIL

Stelrad's Classic Towel Rails offer stylish looks and effective heating and drying performance in any kitchen or bathroom. Available from stock in white, chrome, straight or curved.

RANGE	26
TYPES	Mini, Straight, Curved
HEIGHTS (MM)	678 - 1744
LENGTHS (MM)	400, 500, 600
OUTPUTS (WATTS)	240 - 1022
OUTPUTS (BTU/HR)	754 - 3211
COLOURS	White, Chrome
WORKING PRESSURE	8 bar

Please refer to page 50 for technical information.







DECORATIVE COLLECTION

# STR

(STELRAD TOWEL RADIATOR)

The simple design of the Stelrad Towel Radiator is the ultimate in neat, efficient functionality for towel warming and space heating. The superbly integrated unit allows towels and clothes to warm without interfering with the vital flow of convected room heat.

RANGE	5
TYPES	K1
HEIGHTS (MM)	645, 745
LENGTHS (MM)	425, 625, 825
OUTPUTS (WATTS)	419 - 922
OUTPUTS (BTU/HR)	1430 - 3147
COLOURS	White RAL 9016
WORKING PRESSURE	10 bar

Please refer to page 53 for technical information.



DECORATIVE COLLECTION

# CALIENTE RAIL

Elegant tube on tube design consisting of a tight array of slim tubes makes the Stelrad Caliente Rail an easy choice for any bathroom or kitchen whether it's a modern, contemporary or period interior.

RANGE	32
TYPES	Straight Single, Straight Double
HEIGHTS (MM)	755 - 2013
LENGTHS (MM)	450 - 750
OUTPUTS (WATTS)	389 - 2321
OUTPUTS (BTU/HR)	1327 - 7919
COLOURS	36
WORKING PRESSURE	6 bar

Comes in White as standard (RAL 9016).

Please refer to page 55 for technical information.  
Please refer to page 72 for colour options.

All colour radiators have up to an 8 week lead time, and when a coloured radiator or radiators have been ordered they cannot be cancelled or returned.



A3002 Carmine red



A5002 Ultramarine blue



ML120 Titanium grey



ML120 Titanium grey





ML130 Blue grey



DECORATIVE COLLECTION

# CALIENTE CURVED RAIL

The stylish Stelrad Caliente Curved Rail will complement your bathroom or en-suite whatever the décor.

RANGE	6
TYPES	Curved Single
HEIGHTS (MM)	1199, 1791, 2013
LENGTHS (MM)	496, 595
OUTPUTS (WATTS)	675 - 1294
OUTPUTS (BTU/HR)	2303 - 4415
COLOURS	36
WORKING PRESSURE	6 bar

Comes in White as standard (RAL 9016).

Please refer to page 57 for technical information.  
Please refer to page 72 for colour options

All colour radiators have up to an 8 week lead time, and when a coloured radiator or radiators have been ordered they cannot be cancelled or returned.

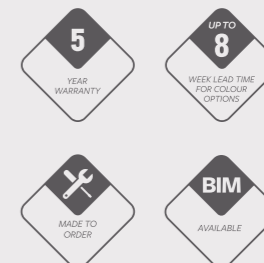

DECORATIVE COLLECTION

# CONCORD RAIL

The Stelrad Concord Rail offers a stunning alternative to tubular towel rails, with its flat tube on tube. Offering visual appeal combined with advanced technology, the Stelrad Concord Rail provides a contemporary solution for a wide range of building applications.

RANGE	8
TYPES	Straight Single
HEIGHTS (MM)	731 - 1771
LENGTHS (MM)	450, 600
OUTPUTS (WATTS)	342 - 1010
OUTPUTS (BTU/HR)	1167 - 3446
COLOURS	36
WORKING PRESSURE	4 bar

Comes in White as standard (RAL 9016).

Please refer to page 58 for technical information.  
Please refer to page 72 for colour options.

All colour radiators have up to an 8 week lead time, and when a coloured radiator or radiators have been ordered they cannot be cancelled or returned.



A7001 Silver grey



NT160 Pebble grey

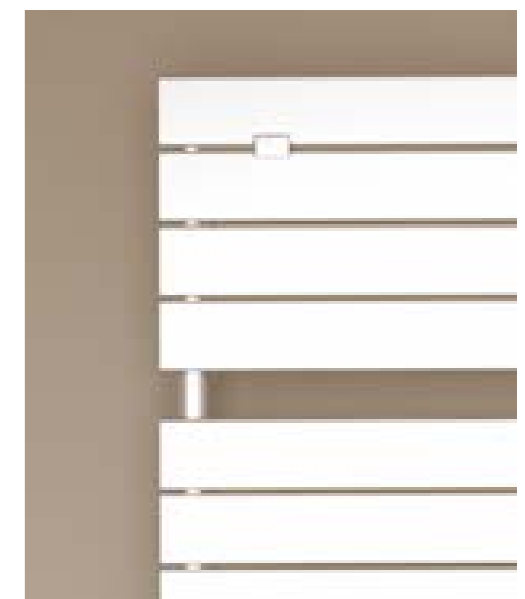



DECORATIVE COLLECTION

ESPRIT

Elegant and ultra slim, the Stelrad Esprit is a beautifully stylish range of radiators that's great for space saving and it looks simply stunning.

RANGE	16
TYPES	Straight, Curved
HEIGHTS (MM)	900 - 1800
LENGTHS (MM)	450, 550
OUTPUTS (WATTS)	316 - 1056
OUTPUTS (BTU/HR)	1079 - 3604
COLOURS	White, Chrome
WORKING PRESSURE	5 bar

Please refer to page 60 for technical information.

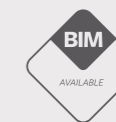

## DESIGNER COLLECTION

Offering design excellence, guaranteed performance and bespoke finishing options, our unique Designer Collection is the ultimate choice for any homeowner seeking an individual, statement radiator for their kitchen or bathroom. Consisting of six product options including the innovative 'Optia' and the curved 'Arc and Wave', this high quality, high performance collection promises to deliver distinction to your room.





ML170 Graphite black



ML170 Graphite black



NT120 Pearl white

DESIGNER COLLECTION

## VERTICAL ULTRA

Outstanding performance and the beautiful design of the Stelrad Vertical Ultra elevates any room. Available in a range of bespoke colour finishes, and optional towel rails (see page 63), the Vertical Ultra is perfectly suited for bathrooms and kitchens.

RANGE	12
TYPES	K2
HEIGHTS (MM)	1000 - 2000
LENGTHS (MM)	500, 600, 700
OUTPUTS (WATTS)	857 - 2376
OUTPUTS (BTU/HR)	2924 - 8107
COLOURS	36*
WORKING PRESSURE	10 bar

Please refer to page 63 for technical information.  
Please refer to page 72 for colour options.

\*Please note: When choosing a colour only the front fascia panel can be coloured. Where the product height is 1000mm and 1200mm, the emitter, top grille and side panels are black. If the product height is 1800mm and 2000mm, the emitter, top grille and side panels are white.

All Vita Ultra radiators have up to an 8 week lead time, and when a coloured radiator or radiators have been ordered they cannot be cancelled or returned.



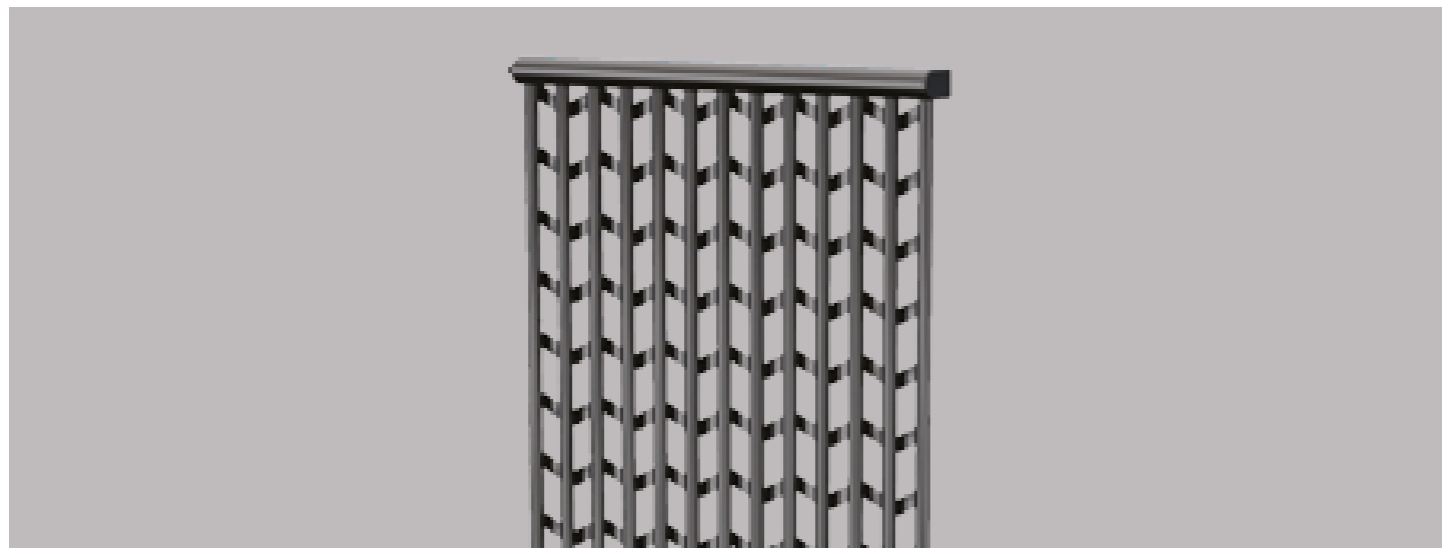

DESIGNER COLLECTION

# EXCEL

The Excel is a practical and stylish lattice design radiator for domestic or commercial applications.

RANGE	3
TYPES	Wall Mounted
HEIGHTS (MM)	1800, 2000
LENGTHS (MM)	380, 500
OUTPUTS (WATTS)	727 - 1048
OUTPUTS (BTU/HR)	2481 - 3577
COLOURS	Jet Black RAL 9005
WORKING PRESSURE	5 bar

Please refer to page 64 for technical information.





DESIGNER COLLECTION

# ARC & WAVE

Precision curved, fine tubes define the elegant lines of the Arc and Wave, make spaces that little bit more special and create a clear style statement for any living space.

RANGE	6
TYPES	Arc, Wave
HEIGHTS (MM)	1800
LENGTHS (MM)	380, 440, 620
OUTPUTS (WATTS)	882 - 1438
OUTPUTS (BTU/HR)	3010 - 4908
COLOURS	Metallic grey BR0007
WORKING PRESSURE	5 bar

Please refer to page 65 for technical information.



Wave

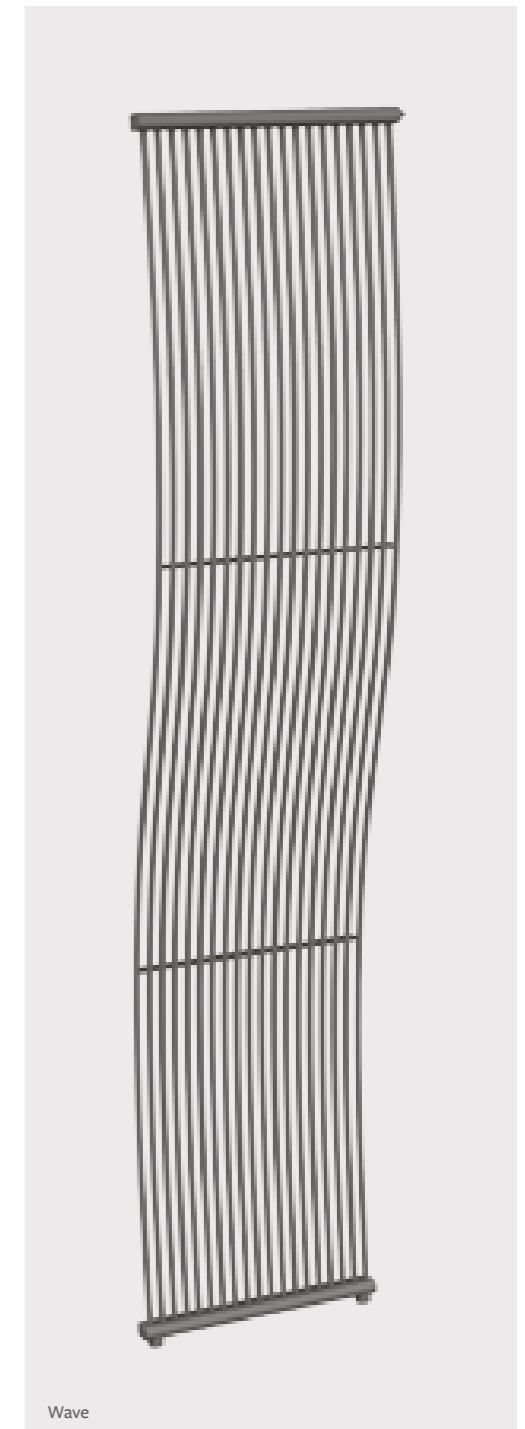

Wave



Arc

DESIGNER COLLECTION

# VISTALINE

The tightly aligned slim tubes of the Stelrad Vistaline don't just look great, they also deliver a superb heating performance. Available with tubes in a single or staggered double row for maximum output flexibility, and in a wide range of colours.

RANGE	11
TYPES	Single Row, Double Row
HEIGHTS (MM)	1800, 2000
LENGTHS (MM)	320 - 740
OUTPUTS (WATTS)	742 - 1886
OUTPUTS (BTU/HR)	2532 - 6437
COLOURS	35
WORKING PRESSURE	5 bar

Please refer to page 66 for technical information.  
Please refer to page 72 for colour options.



All colour radiators have up to an 8 week lead time, and when a coloured radiator or radiators have been ordered they cannot be cancelled or returned.

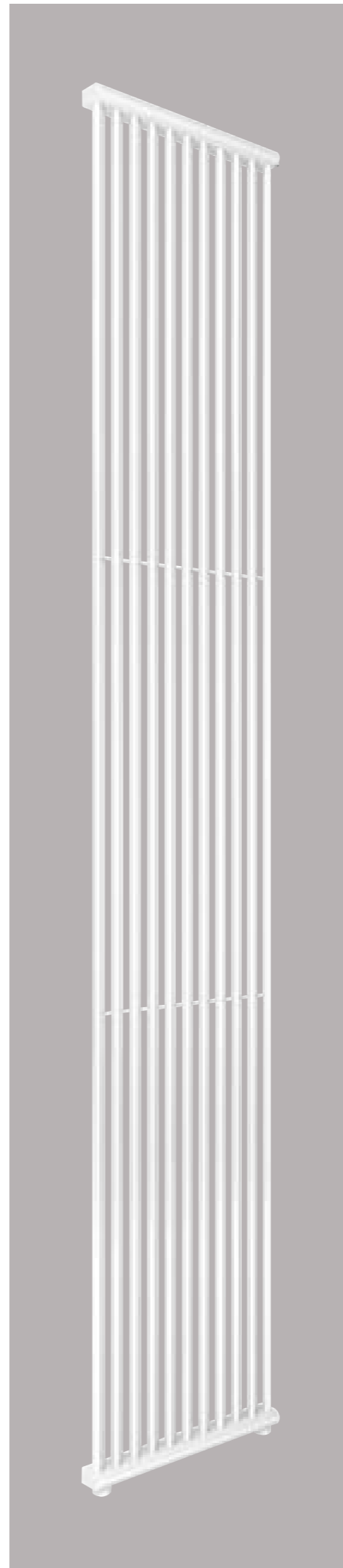



DESIGNER COLLECTION

# ELLIPSE

Vertical C shaped tubes in inward or outward facing columns give the Stelrad Ellipse a distinctive look and make it a feature in any room. The large capacity of the tubes also delivers outstanding heating performance. Available in a wide range of colours.

RANGE	10
TYPES	Inward Facing Columns, Outward Facing Columns
HEIGHTS (MM)	1800, 2000
LENGTHS (MM)	459, 689, 765
OUTPUTS (WATTS)	858 - 1590
OUTPUTS (BTU/HR)	2928 - 5427
COLOURS	35
WORKING PRESSURE	5 bar

Please refer to page 68 for technical information.  
Please refer to page 72 for colour options.



All colour radiators have up to an 8 week lead time, and when a coloured radiator or radiators have been ordered they cannot be cancelled or returned.



DESIGNER COLLECTION

# OPTIA

Pietro Facheris' iconic design, affectionately known as the 'boat', delivers excellent heat output and cleverly integrated towel stacking spaces. Available in three lengths, and finished in cool metallic grey.

RANGE	3
TYPES	Optia
HEIGHTS (MM)	1800
LENGTHS (MM)	160, 200, 240
OUTPUTS (WATTS)	742 - 1114
OUTPUTS (BTU/HR)	2532 - 3802
COLOURS	Metallic grey BR0007
WORKING PRESSURE	5 bar

Please refer to page 70 for technical information.



# TECHNICAL INFORMATION

ACCESSORIES  
OUTPUTS  
DIMENSIONS  
FITTINGS  
ASSEMBLY  
FINISHES

We recommend that you place the brackets between the 2nd and 3rd pipes 80mm from the radiator to the centre of the bracket.

INSERT

80MM

360°

# Technical information

## Extra performance to guaranteed standards

Stelrad combine the most sophisticated production resources in Europe with substantial investment in testing and verification of performance data - which has helped us create high output radiators delivering heating performance that exceeds expectation.

## More choice for application flexibility

A range of models provide extra sizing flexibility and covers a multitude of application requirements, including those where there are installation difficulties or where wall space is at a premium.

## Superb quality from design to installation

Our radiators are specifically designed to minimise any movement, providing a tight, professional fit that will remain in place, even after storage, transit and installation. Convectors are precision welded directly onto the waterways for greater efficiency and economy, with flexible connection options for the highest of commercial and domestic application specifications.

Stelrad radiators are manufactured under ISO 9001 quality systems in the UK and every one comes wrapped in robust, practical packaging that will keep the product pristine, right through to installation. This clever packaging design allows installation to be completed prior to removal.

## Temperature table

For systems not operating at  $\Delta t_{50}$  the factors in the table below should be applied. The output of a given radiator can be obtained by multiplying the quoted  $\Delta t_{50}$  output by the operating factor. Conversely, to derive a non  $\Delta t_{50}$  output, divide the heat output required by the relevant operation factor. This ' $\Delta t_{50}$  equivalent output' can then be used to select a radiator from the standard tables.

$\Delta t$	$^{\circ}\text{C}$		$^{\circ}\text{F}$	
	$\Delta t$	Operating Factor	$\Delta t$	Operating Factor
5	5	0.050	10	0.057
10	10	0.123	20	0.142
15	15	0.209	30	0.240
20	20	0.304	40	0.348
25	25	0.406	50	0.466
30	30	0.515	60	0.590
35	35	0.629	70	0.721
40	40	0.748	80	0.858
45	45	0.872	90	1.000
50	50	1.000	100	1.147
55	55	1.132	110	1.298
60	60	1.267	120	1.454
65	65	1.406	130	1.613
70	70	1.549	150	1.776
75	75	1.694	-	-

Example: Exact output at  $\Delta t_{50} = 2000$  Btu/hr  
Output at  $\Delta t_{30} = 2000 \times 0.515 = 1030$  Btu/hr  
Average coefficient of 130 is used in the example above

## Applications

Stelrad radiators are suitable for two pipe installations. For single pipe applications, it is advisable to use diversion tees in the pipework, as this will assist in obtaining design performance from the radiators. Although our radiators are suitable for Microbore pipework, the back tappings make them unsuitable for twin entry valves.

## Installation

Everything required for installation can be found within each radiator's packaging. Brackets are of a strong design, with open top and deep slots, which facilitate easy and secure installation. Plastic inserts seat the radiator precisely on the bracket minimising expansion and contraction noise.

The neat nickel-plated plug and vent provide a watertight joint, whilst complementing the superior finish.

To facilitate easy one off replacement, nickel-plated brass extension pieces are also available, complete with sealing washer, in 20mm, 30mm and 40mm options. Recommended height from the floor to the base of the radiator is 150mm minimum. This allows adequate airflow when the radiator is placed on the bracket.

## Caution

When designing for domestic systems we recommend that the Stelrad radiators are only used in heating systems complying with British Standard Code of Practice for Central Heating for Domestic Premises BS EN 12828:2003 and BS EN 12831:2003.

Single feed, direct cylinders are not recommended as should interchange of water occur, fresh aerated water would enter the heating system, resulting in corrosion.

## Water treatment

On completion of the installation, the system should be properly flushed and filled in accordance with the British Standard Code of Practice BS 7593:2006 for the Treatment of Water in Domestic Hot Water Central Heating Systems, Part L of Building Regulations and Good Practice Guidance for Scotland.

After installation of a new Stelrad radiator the central heating system should be cleaned and flushed with cleaner to remove existing contaminants, flux residue and other installation debris which, if left, can cause damage to the new radiator. Afterwards, treat the system with an inhibitor to ensure long term protection against corrosion and limescale.

A comprehensive range of quality chemicals including inhibitors, cleaners, leak sealers and noise reducers that protect and maintain central heating systems can be obtained from:

### Sentinel Performance Solutions Ltd

7650 Daresbury Park,  
Warrington,  
Cheshire, WA4 4BS,  
[www.sentinelprotects.com](http://www.sentinelprotects.com)

### Fernox

Unit 2 Genesis Business Park,  
Albert Drive, Sheerwater,  
Woking, Surrey,  
GU21 5RW  
[www.fernox.com](http://www.fernox.com)

## Two coat paint process

Each Stelrad radiator is subjected to a multi stage cleaning process before the paint is applied. This involves several rinsing stages, including an iron phosphate and demineralisation rinse. The first coat of paint is applied by electrophoresis and the radiator is then stoved and cooled. The second powder coat is applied and the radiator goes through a final curing stage. It is then allowed to cool, prior to packaging.



STELRAD'S ADVANCED  
HEATLOSS CALCULATOR

The Stelrad STARS Heatloss Calculator contains an inbuilt U value calculator.

Save time and effort by using the Stelrad STARS program - the perfect solution for accurate sizing and design flexibility.

Visit [www.starsapp.co.uk](http://www.starsapp.co.uk)

For further information and advice call 0844 543 6200.

# Accessories

## VERTICAL ULTRA TOWEL RAIL BAR

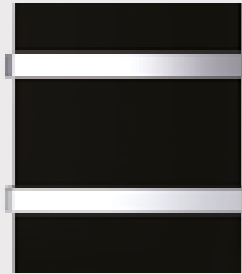

400mm UIN 83200004  
500mm UIN 83200005  
600mm UIN 83200006  
Available for the  
Vertical Ultra only.

## CHROME ROBE HOOKS

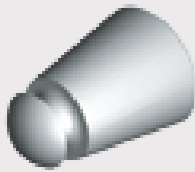

UIN 147988  
Available for the Vistaline,  
Ellipse & Esprit only.

## ADDITIONAL TOWEL RAIL



300mm UIN 147995  
400mm UIN 147996  
460mm UIN 147997  
620mm UIN 147998  
Available for the Ellipse,  
Esprit & Vistaline Only.

## DRYING AND STACKING RAIL



UIN 147999  
ME46 Chrome  
Available for the  
Vistaline & Ellipse only.

## EXTENSION PIECES



Optional extension pieces  
for easy replacement.  
20mm UIN 9176  
30mm UIN 9177  
40mm UIN 9178

Available for all the products  
within the Vita Series, Aqua  
Series, Stelrad Series, Softline  
Series, Designer Series &  
Special Application Series.

## 3/4" VALVE ADAPTOR



Optional 3/4" valve adaptor for  
connection without performance  
reduction.  
UIN 140117

Available for all the products  
in the Vita Series, Aqua Series,  
Stelrad Series & Special  
Application Series.

## TOWEL RAIL ELECTRIC HEATER ELEMENT

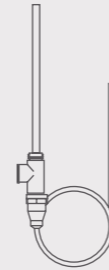

Electric heating element  
150 watt UIN 141536  
300 watt UIN 141531  
615 watt UIN 141532

Available for the Classic Towel  
Rail, Caliente Rail, Caliente  
Curved Rail & Concord Rail.

## ESPRIT ELECTRIC HEATER ELEMENT

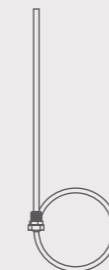

Electric heating element  
350 watt UIN 148000  
650 watt UIN 148001  
900 watt UIN 148002

Available for Esprit only.

## OPTIONAL FITTINGS SUPPLIED

1/2" Blanking Plug  
UIN 140072



Available for all  
products in the  
Aqua Series.

T-Piece  
UIN 141533



Available for the:  
Aqua Series (not Esprit).

## ROBUST PACKAGING



Robust packaging protects the product  
right through to hand over. Installation  
instructions can be found on the reverse  
of the identification label.

Example packaging above, the packaging  
for each radiator will vary.

## ALL FIXINGS



All fixing requirements are complete  
within the packaging. Content will vary  
depending on product.

## TECHNICAL INFORMATION

### Decorative Collection

**NEW** Slimline Towel Rail

Classic Towel Rail

STR (Stelrad Towel Radiator)

Caliente Rail

Caliente Curved Rail

Concord Rail

Esprit

### Designer Collection

Vertical Ultra

Excel

Arc & Wave

Vistaline

Ellipse

Optia



# NEW Slimline Towel Rail

Stelrad Aqua Series

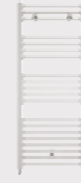

**50 Δt**  
(75/65/20°C)

## STRAIGHT CHROME

Height mm	Length mm	Max Projection mm	Stelrad UIN	Heat output Watts	Heat output Btu/hr	Price excl VAT	Price incl VAT
<b>650</b>	400	100	148700	174	594	£66.80	£80.16
<b>803</b>	500	100	148701	236	806	£75.50	£90.60
	600	100	148702	268	915	£81.24	£97.49
<b>1188</b>	500	100	148703	345	1178	£91.05	£109.26
	600	100	148704	402	1372	£109.26	£131.11
<b>1600</b>	500	100	148705	467	1594	£134.56	£161.47
	600	100	148706	548	1870	£161.48	£193.78
<b>1785</b>	500	100	148707	524	1788	£167.82	£201.38
	600	100	148708	614	2095	£201.38	£241.66

Δt50 is the UK's industry standard for heating outputs, which has an operating temperature of 75/65/20°C. If you have a low temperature heat source you may wish to consider Δt40 or Δt30 output (see your installer or system designer or download from [www.stelrad.com](http://www.stelrad.com)).

## EN 442 CERTIFICATION DATA - CETIAT TESTED IN ACCORDANCE WITH BS EN 442

Type	STRAIGHT CHROME									
No of tubes	12	13	13	20	20	27	27	31	31	
Height	650	803	803	1188	1188	1600	1600	1785	1785	
Length	400	500	600	500	600	500	600	500	600	
Watts at 75/65/20	174	236	268	345	402	467	548	524	614	
n-coefficients	1.21	1.18	1.19	1.20	1.21	1.23	1.23	1.24	1.24	
Weight (kg)	4.10	5.40	6.30	8.20	9.60	10.50	11.90	12.80	14.80	
Water contents (l/m)	2.50	3.30	3.90	4.80	5.60	5.90	7.20	7.30	8.30	

## CONNECTIONS

Each radiator comes with 1/2" inlet connections as standard.

# NEW Slimline Towel Rail

Stelrad Aqua Series



## WALL MOUNTING INFORMATION

All dimensions in mm. Inches in brackets.

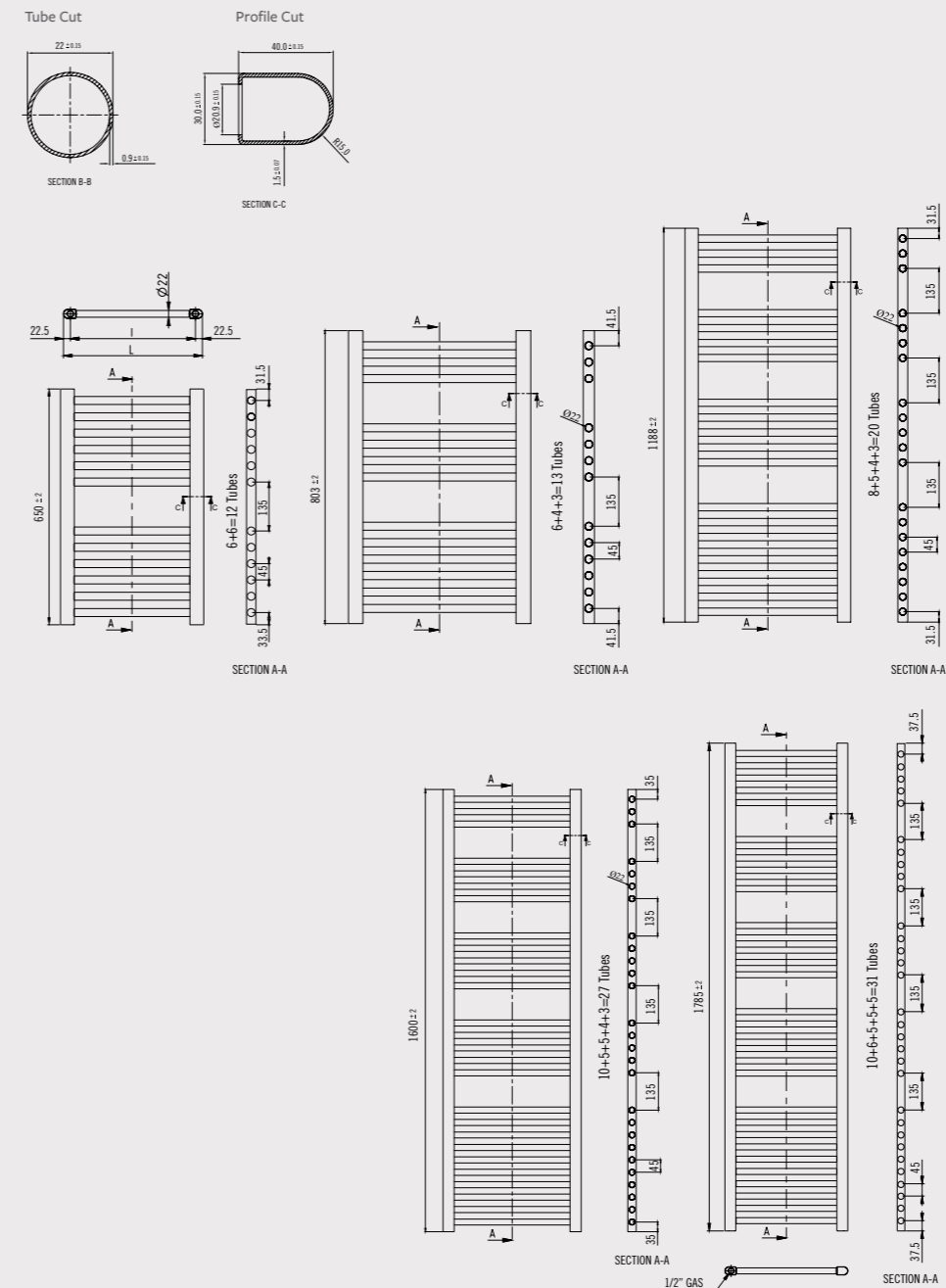

# Classic Towel Rail

**Stelrad** Aqua Series



**50 Δt**  
(75/65/20°C)

## STRAIGHT WHITE

Height mm	Length mm	Max Projection mm	Stelrad UIN	Heat output Watts	Heat output Btu/hr	Price excl VAT	Price incl VAT	Max Projection mm	Stelrad UIN	Heat output Watts	Heat output Btu/hr	Price excl VAT	Price incl VAT
<b>760</b>	500	100	148070	367	1153	£99.31	£119.17	100	147002	305	958	£197.41	£236.89
	600	100	148071	439	1379	£100.59	£120.71	100	147003	366	1150	£206.09	£247.31
<b>1211</b>	500	100	148072	545	1712	£132.90	£159.48	100	147004	454	1426	£263.96	£316.75
	600	100	148073	646	2030	£136.71	£164.05	100	147005	539	1694	£280.64	£336.77
<b>1744</b>	500	100	148074	804	2526	£205.60	£246.72	100	142768	670	2105	£332.07	£398.48
	600	100	148075	951	2988	£221.45	£265.74	100	142769	792	2488	£355.51	£426.61

## STRAIGHT CHROME

## CURVED WHITE

Height mm	Length mm	Max Projection mm	Stelrad UIN	Heat output Watts	Heat output Btu/hr	Price excl VAT	Price incl VAT	Max Projection mm	Stelrad UIN	Heat output Watts	Heat output Btu/hr	Price excl VAT	Price incl VAT
<b>760</b>	500	100	147006	394	1238	£126.54	£151.85	100	147012	328	1031	£246.33	£295.60
	600	100	147007	472	1483	£134.54	£161.45	100	147013	393	1235	£269.91	£323.89
<b>1211</b>	500	100	147008	586	1841	£168.45	£202.14	100	147014	488	1533	£310.16	£372.19
	600	100	147009	695	2184	£206.96	£248.35	100	147015	579	1819	£317.79	£381.35
<b>1744</b>	500	100	147010	864	2715	£209.55	£251.46	100	147016	720	2262	£378.62	£454.34
	600	100	147011	1022	3211	£235.13	£282.16	100	147017	852	2677	£439.25	£527.10

## CURVED CHROME

Δt50 is the UK's industry standard for heating outputs, which has an operating temperature of 75/65/20°C. If you have a low temperature heat source you may wish to consider Δt40 or Δt30 output (see your installer or system designer or download from [www.stelrad.com](http://www.stelrad.com)).

### EN 442 CERTIFICATION DATA - CETIAT TESTED IN ACCORDANCE WITH BS EN 442

Type	STRAIGHT/CURVED WHITE					
No of tubes	16	16	25	25	36	36
Height	760	760	1211	1211	1744	1744
Length	500	600	500	600	500	600
Watts at 75/65/20	376	445	576	686	844	1000
n-coefficients	1.23	1.23	1.25	1.25	1.28	1.26
Heated surface area (m <sup>2</sup> )	0.71	0.83	1.11	1.30	1.60	1.88
Weight (kg)	6.12	7.06	9.63	11.10	13.86	15.98
Water contents (l/m)	4.41	5.10	6.89	7.97	9.80	11.40
KM (P/dTr)	3.0343	3.5743	4.285	5.2327	5.6826	7.1623

Type	STRAIGHT/CURVED CHROME					
No of tubes	16	16	25	25	36	36
Height	760	760	1211	1211	1744	1744
Length	500	600	500	600	500	600
Watts at 75/65/20	246	294	379	453	557	667
n-coefficients	1.25	1.25	1.28	1.27	1.30	1.30
Heated surface area (m <sup>2</sup> )	0.71	0.83	1.11	1.30	1.60	1.88
Weight (kg)	6.12	7.06	9.63	11.10	13.86	15.98
Water contents (l/m)	4.41	5.10	6.89	7.97	9.80	11.40
KM (P/dTr)	1.8179	2.1949	2.5779	3.1188	3.4249	4.1610

# Classic Towel Rail

**Stelrad** Aqua Series



		STRAIGHT MODELS					CURVED MODELS				
		WALL MOUNTING POSITIONS					WALL MOUNTING POSITIONS				
A Width (mm)	B Height (mm)	C Depth (mm)	D Tap Centres (mm)	EE (mm)	F (mm)	C (mm)	C Depth (mm)	D Tap Centres (mm)	EE (mm)	F (mm)	C (mm)
400	678	30	356	70	216	65-75	-	-	-	-	-
500	760	30	456	70	316	65-75	56.0	456	110	236	40-45
600	760	30	556	70	416	65-75	60.0	556	110	336	40-45
500	1211	30	456	70	316	65-75	56.0	456	110	236	40-45
600	1211	30	556	70	416	65-75	60.0	556	110	336	40-45
500	1744	30	456	70	316	65-75	56.0	456	110	236	40-45
600	1744	30	556	70	416	65-75	60.0	556	110	336	40-45

### STRAIGHT MODELS

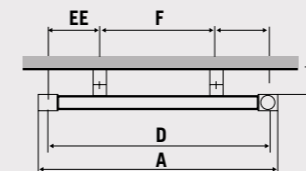

### CURVED MODELS

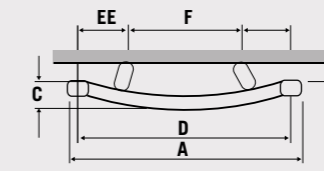

### NUMBER OF TUBES ON TOWEL RAILS

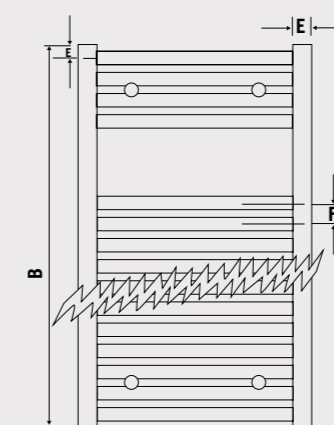
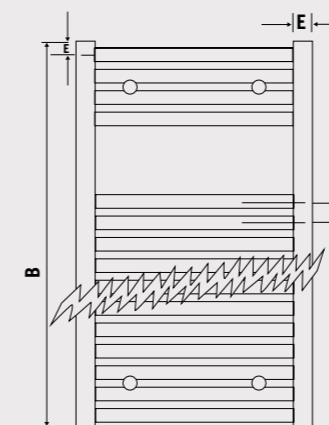
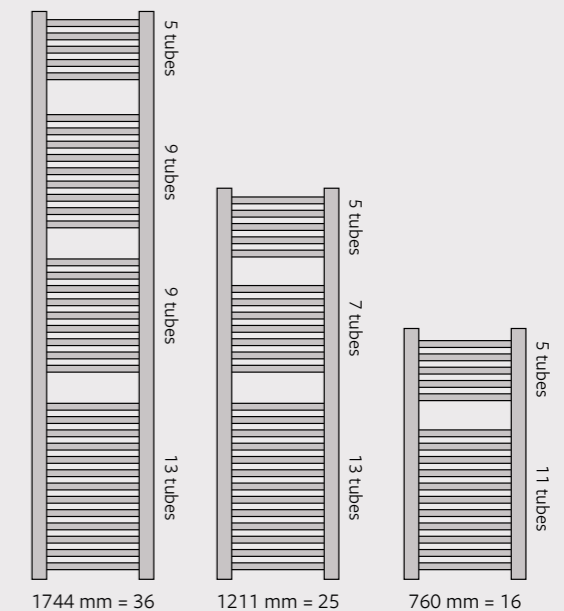

### BRACKET POSITIONS

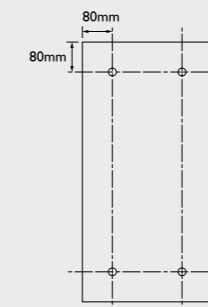

### CONNECTIONS

Each radiator comes with 1/2" inlet connections as standard.

# Classic Mini Towel Rail

**Stelrad** Aqua Series



**50 Δt**  
(75/65/20°C)

Height mm	Length mm	Max Projection mm	WHITE				CHROME						
			Stelrad UIN	Heat output Watts	Heat output Btu/hr	Price excl VAT	Price incl VAT	Stelrad UIN	Heat output Watts	Heat output Btu/hr	Price excl VAT	Price incl VAT	
<b>678</b>	400	100	147000	280	880	£73.91	£88.69	100	147001	240	754	£139.34	£167.21

Δt50 is the UK's industry standard for heating outputs, which has an operating temperature of 75/65/20°C. If you have a low temperature heat source you may wish to consider Δt40 or Δt30 output (see your installer or system designer or download from [www.stelrad.com](http://www.stelrad.com)).

## EN 442 CERTIFICATION DATA - CETIAT TESTED IN ACCORDANCE WITH BS EN 442

Type	WHITE	CHROME
No of tubes	14	14
Height	14	14
Length	678	678
Watts at 75/65/20	400	175
n-coefficients	1.2232	1.2535
Heated surface area (m <sup>2</sup> /m)	0.51	0.51
Weight (kg/m)	4.57	4.57
Water contents (l/m)	3.20	3.20
KM (P/dTr)	2.2803	1.2983

## WALL MOUNTING INFORMATION

All dimensions in mm. Inches in brackets.

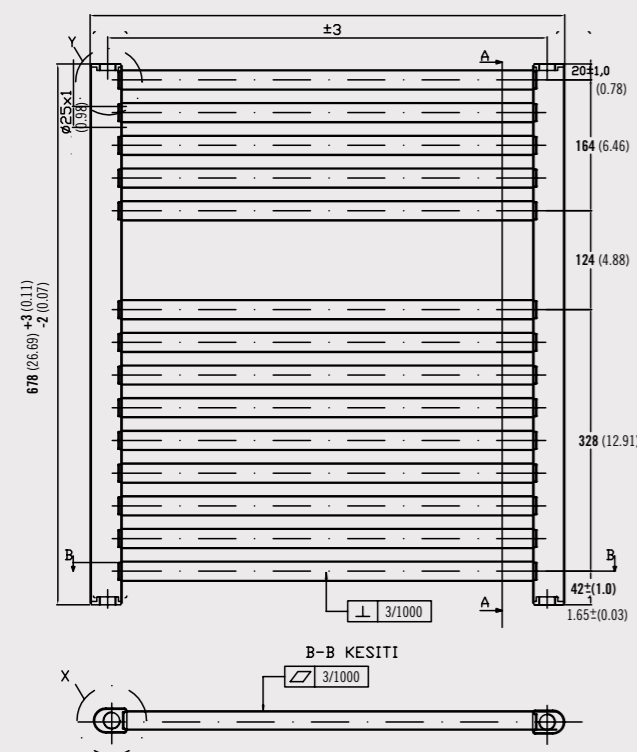

## NUMBER OF TUBES ON TOWEL RAILS

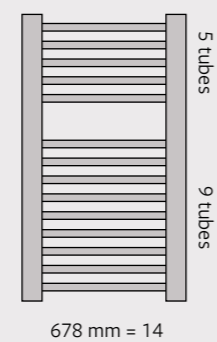

## CONNECTIONS

Each radiator comes with 1/2" inlet connections as standard.

# STR (Stelrad Towel Radiator)

**Stelrad** Aqua Series



**50 Δt**  
(75/65/20°C)

Height mm	Length mm	Sections	STR2				STR3				STR4						
			Stelrad UIN	Heat output Watts	Heat output Btu/hr	Price excl VAT	Price incl VAT	Stelrad UIN	Heat output Watts	Heat output Btu/hr	Price excl VAT	Price incl VAT	Stelrad UIN	Heat output Watts	Heat output Btu/hr	Price excl VAT	Price incl VAT
<b>645</b>	425	12	140129	419	1430	£136.02	£163.22	-	-	-	-	-	-	-	-	-	-
	625	18	-	-	-	-	-	140130	611	2085	£172.96	£207.55	-	-	-	-	-
<b>745</b>	425	12	-	-	-	-	-	-	-	-	-	-	140022	475	1621	£140.26	£168.31

Height mm	Length mm	Sections	STR6				STR8						
			Stelrad UIN	Heat output Watts	Heat output Btu/hr	Price excl VAT	Price incl VAT	Stelrad UIN	Heat output Watts	Heat output Btu/hr	Price excl VAT	Price incl VAT	
<b>745</b>	625	18	140023	693	2365	£181.84	£218.21	-	-	-	-	-	-
	825	24	-	-	-	-	-	140024	922	3147	£215.12	£258.14	-

Δt50 is the UK's industry standard for heating outputs, which has an operating temperature of 75/65/20°C. If you have a low temperature heat source you may wish to consider Δt40 or Δt30 output (see your installer or system designer or download from [www.stelrad.com](http://www.stelrad.com)).

## EN 442 CERTIFICATION DATA - CETIAT TESTED IN ACCORDANCE WITH BS EN 442

Type	STR2	STR3	STR4	STR6	STR8
Height	645	645	745	745	745
W/m at 75/65/20	419	611	475	693	922
n-coefficients	1.27	1.27	1.28	1.28	1.28
Heated surface area (m <sup>2</sup> /m)	1.86	2.79	2.21	3.31	4.41
Weight (kg/m)	8.72	13.08	9.95	14.92	19.89
Water contents (l/m)	1.32	1.98	1.56	2.34	3.12

# STR (Stelrad Towel Radiator)



## MOUNTING BRACKETS

All dimensions in mm. Inches in brackets.

Dimensions	mm	in	mm	in
	700	27.56	600	23.62
A	65	2.56	65	2.56
B	99	3.90	99	3.90
C	519	20.43	419	16.50
D	553	21.77	453	17.83
E	585	23.03	485	19.09

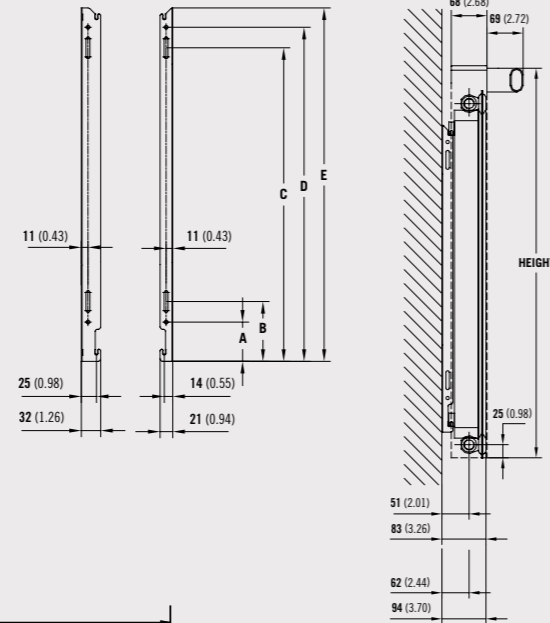

## CONNECTIONS

Each radiator comes with 1/2" inlet connections as standard.

## WALL MOUNTING INFORMATION

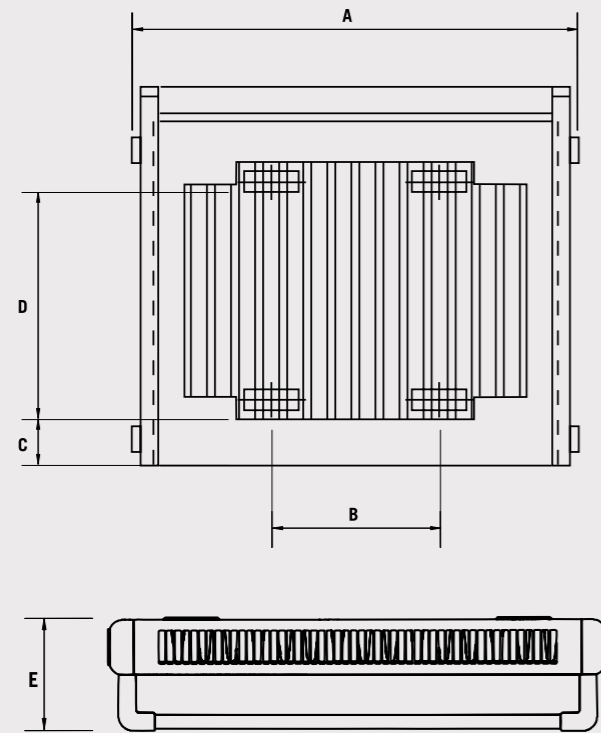

Dimensions	STR2		STR3		STR4		STR6		STR8	
	mm	in	mm	in	mm	in	mm	in	mm	in
A	425	16.73	625	24.60	425	16.73	625	24.60	825	32.48
B	167	6.57	300	11.81	167	6.57	300	11.81	500	19.68
C	60	2.36	60	2.36	60	2.36	60	2.36	60	2.36
D	555	21.85	555	21.85	555	21.85	555	21.85	555	21.85
E	140	5.51	140	5.51	140	5.51	140	5.51	140	5.51

# Caliente Rail



## 50 Δt

(75/65/20°C)

### CALIENTE RAIL SINGLE

Height mm	Lengths mm	Stelrad UIN	Heat output		Price excl VAT	Price incl VAT
			Watts	Btu/hr		
755	450	407501450	389	1327	£238.58	£286.30
	500	407501500	431	1471	£243.86	£292.63
	600	407501600	517	1764	£254.41	£305.29
	750	407501750	645	2201	£274.20	£329.04
1199	450	401101450	615	2098	£275.69	£330.83
	500	401101500	675	2303	£283.38	£340.06
	600	401101600	794	2709	£298.56	£358.27
1791	450	401701450	900	3071	£324.80	£389.76
	500	401701500	986	3364	£335.90	£403.08
	600	401701600	1158	3951	£364.57	£437.48
2013	450	402001450	1002	3419	£344.14	£412.97
	500	402001500	1099	3750	£363.23	£435.88
	600	402001600	1294	4415	£388.43	£466.72
2013	750	402001750	1586	5411	£432.05	£518.46

### CALIENTE RAIL DOUBLE

Height mm	Length mm	Stelrad UIN	Heat output		Price excl VAT	Price incl VAT
			Watts	Btu/hr		
755	450	407502450	552	1883	£302.47	£362.96
	500	407502500	616	2102	£311.65	£373.98
	600	407502600	748	2552	£330.27	£396.32
	750	407502750	947	3231	£362.50	£435.00
1199	450	401102450	868	2962	£365.23	£438.28
	500	401102500	963	3286	£387.63	£465.16
	600	401102600	1154	3937	£415.74	£498.89
1791	450	401702450	1268	4326	£456.09	£547.31
	500	401702500	1402	4784	£477.93	£573.52
	600	401702600	1670	5698	£518.58	£622.30
2013	750	401702750	2073	7073	£608.34	£730.01
	450	402002450	1427	4869	£490.92	£589.10
	500	402002500	1576	5377	£515.33	£618.40
2013	600	402002600	1874	6394	£583.85	£700.62
	750	402002750	2321	7919	£658.77	£790.52

Δt50 is the UK's industry standard for heating outputs, which has an operating temperature of 75/65/20°C. If you have a low temperature heat source you may wish to consider Δt40 or Δt30 output (see your installer or system designer or download from [www.stelrad.com](http://www.stelrad.com)).

For further assistance on colour option UINs and prices, please contact the sales admin team on 0844 543 6200.

# Caliente Rail



## EN 442 CERTIFICATION DATA - CETIAT TESTED IN ACCORDANCE WITH BS EN 442

Type	SINGLE															
Tube Quantity	18	18	18	18	28	28	28	28	42	42	42	42	48	48	48	48
Height	755	755	755	755	1199	1199	1199	1199	1791	1791	1791	1791	2013	2013	2013	2013
Length	450	500	600	750	450	500	600	750	450	500	600	750	450	500	600	750
W/m at 75/65/20	389	431	517	645	615	675	794	972	900	986	1158	1416	1002	1099	1294	1586
n-coefficients	1.18	1.17	1.15	1.13	1.21	1.20	1.19	1.17	1.24	1.23	1.21	1.17	1.26	1.24	1.21	1.17
Heated surface area (m <sup>2</sup> /m)	0.75	0.82	0.94	1.13	1.18	1.28	1.47	1.76	1.77	1.91	2.20	2.64	2.01	2.18	2.51	3.01
Weight (kg/m)	6.80	7.40	8.50	10.20	10.90	11.80	13.50	16.10	17.30	18.60	21.30	25.20	18.90	20.40	23.40	27.80
Water contents (l/m)	3.70	4.00	4.50	5.30	5.90	6.30	7.10	8.30	9.10	9.70	11.00	12.90	10.00	10.70	12.00	14.10

Type	DOUBLE															
Tube Quantity	2x17	2x17	2x17	2x17	2x27	2x27	2x27	2x27	2x41	2x41	2x41	2x41	2x47	2x47	2x47	2x47
Height	755	755	755	755	1199	1199	1199	1199	1791	1791	1791	1791	2013	2013	2013	2013
Length	450	500	600	750	450	500	600	750	450	500	600	750	450	500	600	750
W/m at 75/65/20	565	626	749	934	868	963	1154	1441	1269	1402	1670	2073	1427	1576	1874	2321
n-coefficients	1.21	1.21	1.20	1.19	1.23	1.23	1.22	1.21	1.25	1.24	1.23	1.20	1.25	1.24	1.23	1.21
Heated surface area (m <sup>2</sup> /m)	1.33	1.45	1.70	2.07	2.07	2.26	2.65	3.23	3.10	3.39	3.97	4.85	3.54	3.87	4.53	5.53
Weight (kg/m)	12.47	13.59	15.82	19.17	19.40	21.14	24.61	29.82	29.15	31.75	36.94	44.72	33.20	36.14	42.01	50.82
Water contents (l/m)	6.62	7.19	8.32	10.02	10.30	11.18	12.95	15.59	15.32	16.62	19.23	23.13	17.60	19.11	22.13	26.65
Km	4.91	5.54	6.86	9.00	6.97	7.87	9.77	12.84	9.54	10.84	13.64	18.38	10.66	12.10	15.21	20.48

### SINGLE WALL MOUNTING INFORMATION

All dimensions in mm. Inches in brackets.

### DOUBLE WALL MOUNTING INFORMATION

All dimensions in mm. Inches in brackets.

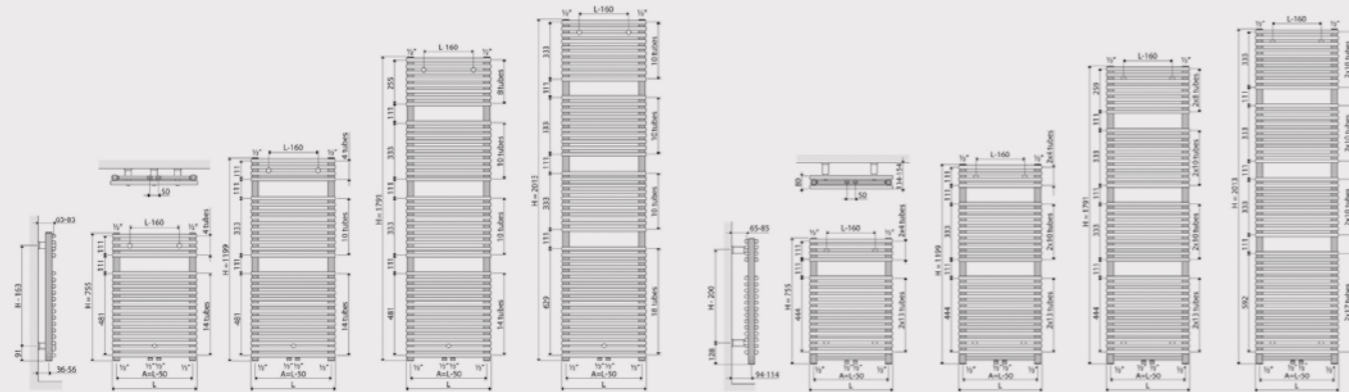

### PIPING OPTIONS

Single and Double.

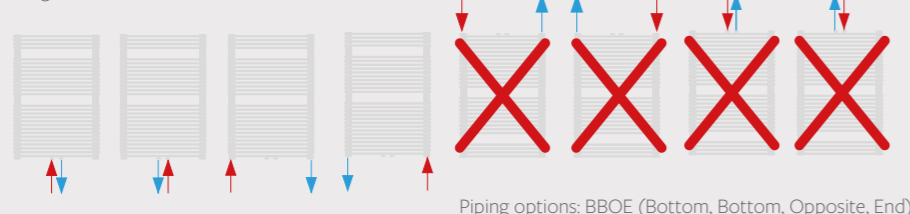

Piping options: BBOE (Bottom, Bottom, Opposite, End)

### CONNECTIONS

Each radiator comes with 1/2" inlet connections as standard.

# Caliente Curved Rail



## 50 Δt (75/65/20°C)

### SINGLE TOWEL RAIL

Height mm	Lengths mm	Stelrad UIN	Heat output Watts	Btu/hr	Price excl VAT	Price incl VAT
1199	496	401101496	675	2303	£387.64	£465.17
	595	401101595	794	2709	£415.74	£498.89
1791	496	401701496	986	3364	£477.93	£573.52
	595	401701595	1158	3951	£518.57	£622.28
2013	496	402001496	1099	3750	£515.33	£618.40
	595	402001595	1294	4415	£583.85	£700.62

## EN 442 CERTIFICATION DATA - CETIAT TESTED IN ACCORDANCE WITH BS EN 442

Type	Single					
Tube Quantity	28	28	42	42	48	48
Height	1199	1199	1791	1791	2013	2013
Length	496	595	496	595	496	595
W/m at 75/65/20	675	794	986	1158	1099	1294
n-coefficients	1.20	1.89	1.23	1.21	2.18	2.51
Heated surface area (m <sup>2</sup> /m)	1.28	1.47	1.91	2.20	2.18	2.51
Weight (kg/m)	11.77	13.52	17.83	20.43	20.38	23.35
Water contents (l/m)	6.29	7.07	9.35	10.54	10.68	12.05
Km	6.11	7.60	8.01	10.31	8.34	11.24

Δt50 is the UK's industry standard for heating outputs, which has an operating temperature of 75/65/20°C. If you have a low temperature heat source you may wish to consider Δt40 or Δt30 output (see your installer or system designer or download from [www.stelrad.com](http://www.stelrad.com)).

### WALL MOUNTING INFORMATION

All dimensions in mm. Inches in brackets.

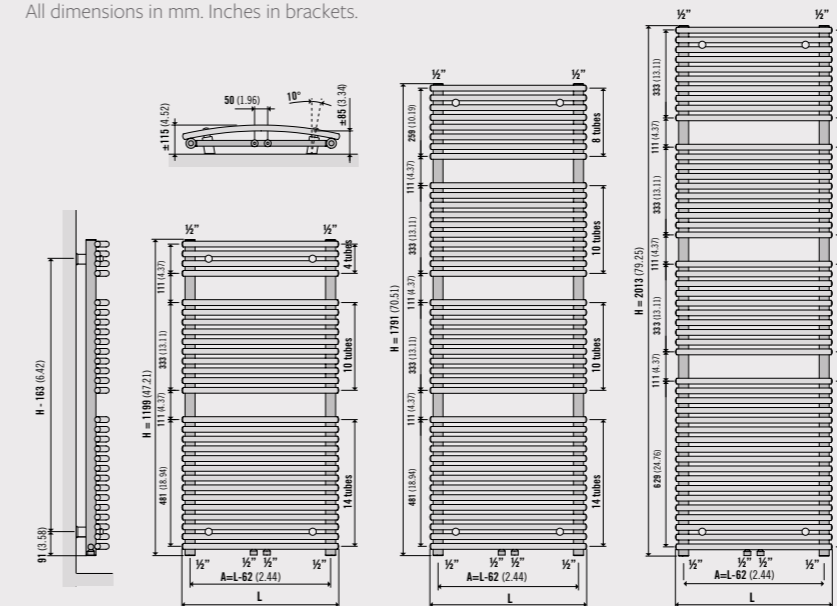

### PIPING OPTIONS

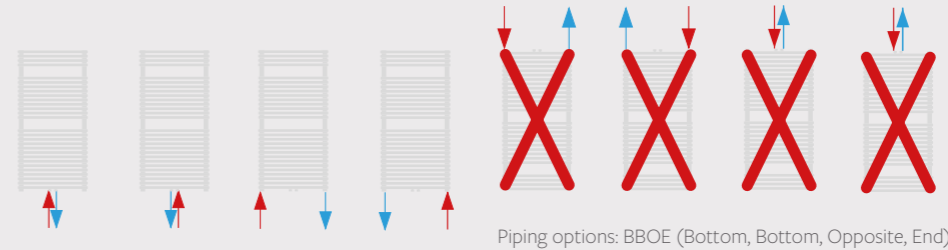

Piping options: BBOE (Bottom, Bottom, Opposite, End)

### CONNECTIONS

Each radiator comes with 1/2" inlet connections as standard.

For further assistance on colour option UINs and prices, please contact the sales admin team on 0844 543 6200.

# Concord Rail



**50  $\Delta t$**   
(75/65/20°C)

## CONCORD RAIL SINGLE

Height mm	Length mm	Tap centres	Stelrad UIN	Heat output		Price excl VAT	Price incl VAT
				Watts	Btu/hr		
<b>731</b>	450	400	148581	342	1167	£268.56	£322.27
	600	550	148582	447	1525	£283.67	£340.40
<b>1186</b>	450	400	148583	530	1808	£339.68	£407.62
	600	550	148584	694	2368	£363.41	£436.09
<b>1511</b>	450	400	148585	666	2272	£388.47	£466.16
	600	550	148586	869	2965	£423.50	£508.20
<b>1771</b>	450	400	148587	777	2651	£439.51	£527.41
	600	550	148588	1010	3446	£474.22	£569.06

$\Delta t50$  is the UK's industry standard for heating outputs, which has an operating temperature of 75/65/20°C. If you have a low temperature heat source you may wish to consider  $\Delta t40$  or  $\Delta t30$  output (see your installer or system designer or download from [www.stelrad.com](http://www.stelrad.com)).

For further assistance on colour option UINs and prices, please contact the sales admin team on 0844 543 6200.

### EN 442 CERTIFICATION DATA - CETIAT TESTED IN ACCORDANCE WITH BS EN 442

Type	Single							
Height	731	731	1186	1186	1511	1511	1771	1771
Length	450	600	450	600	450	600	450	600
W/m at 75/65/20	342	447	530	694	666	869	777	1010
n-coefficients	1.21	1.20	1.25	1.23	1.24	1.23	1.24	1.23
Heated surface area (m <sup>2</sup> /m)	0.82	1.03	1.32	1.66	1.65	2.08	1.97	2.48
Weight (kg/m)	8.90	11.20	14.30	17.90	17.90	22.40	21.40	26.80
Water contents (l/m)	3.20	3.80	5.20	6.20	6.60	7.80	7.80	9.30

# Concord Rail



## WALL MOUNTING INFORMATION

All dimensions in mm. Inches in brackets.

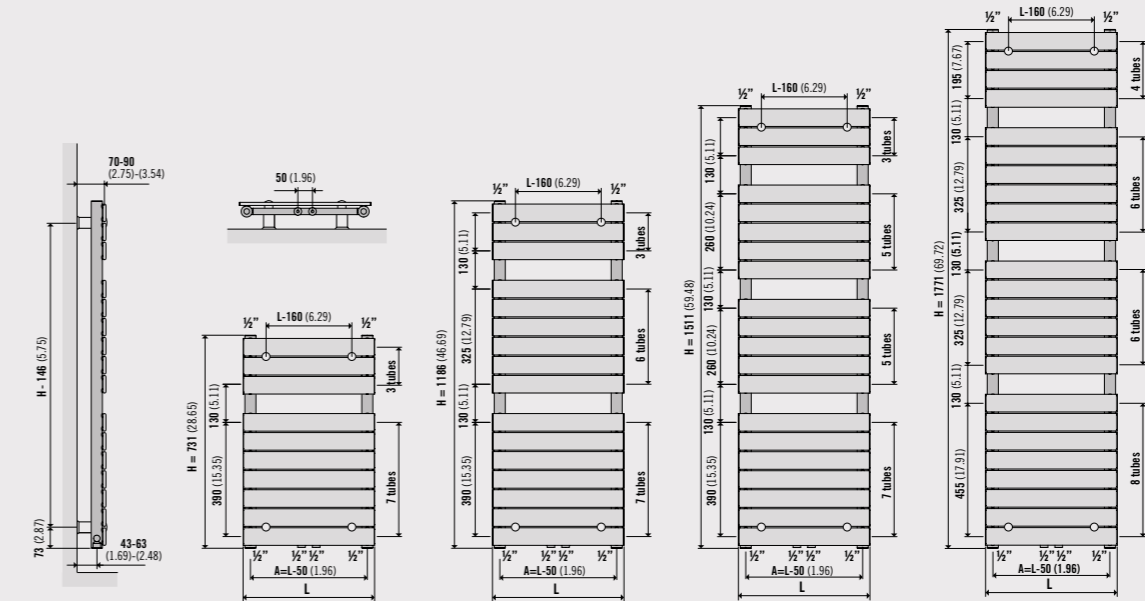

## PIPING OPTIONS

Single

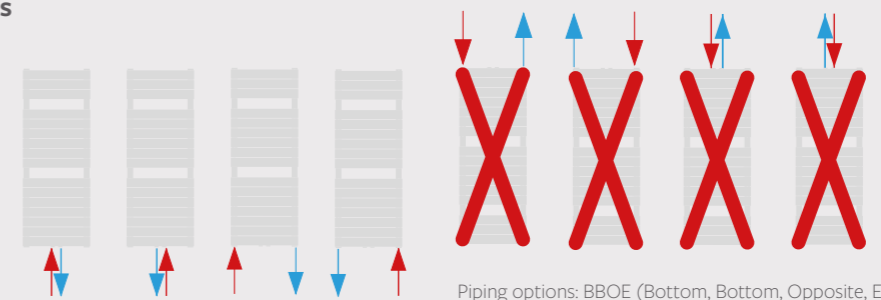

Piping options: BBOE (Bottom, Bottom, Opposite, End)

## CONNECTIONS

Each radiator comes with 1/2" inlet connections as standard.

**50  $\Delta t$**   
(75/65/20°C)



**STRAIGHT WHITE**

**STRAIGHT CHROME**

Height mm	Length mm	Max Projection mm	Stelrad UIN	Heat output Watts	Heat output Btu/hr	Price excl VAT	Price incl VAT	Max Projection mm	Stelrad UIN	Heat output Watts	Heat output Btu/hr	Price excl VAT	Price incl VAT
<b>900</b>	450	100	148049	405	1382	£315.58	£378.70	100	148053	316	1079	£667.75	£801.30
<b>1200</b>	450	100	148050	554	1891	£365.24	£438.29	100	148054	432	1474	£787.17	£944.60
<b>1200</b>	550	100	148051	676	2307	£375.97	£451.16	100	148055	527	1799	£813.60	£976.32
<b>1800</b>	550	100	148052	1056	3604	£511.90	£614.28	100	148056	824	2812	£1,143.37	£1,372.04

$\Delta t50$  is the UK's industry standard for heating outputs, which has an operating temperature of 75/65/20°C. If you have a low temperature heat source you may wish to consider  $\Delta t40$  or  $\Delta t30$  output (see your installer or system designer or download from [www.stelrad.com](http://www.stelrad.com)).

**CURVED WHITE**

**CURVED CHROME**

Height mm	Length mm	Max Projection mm	Stelrad UIN	Heat output Watts	Heat output Btu/hr	Price excl VAT	Price incl VAT	Max Projection mm	Stelrad UIN	Heat output Watts	Heat output Btu/hr	Price excl VAT	Price incl VAT
<b>900</b>	550	75	148057	452	1543	£414.26	£497.11	75	148061	384	1311	£841.03	£1,009.24
<b>1200</b>	550	75	148058	676	2307	£471.13	£565.36	75	148062	527	1799	£959.40	£1,151.28
<b>1500</b>	550	75	148059	860	2935	£560.94	£673.13	75	148063	671	2290	£1,160.61	£1,392.73
<b>1800</b>	550	75	148060	1056	3604	£614.19	£737.03	75	148064	824	2812	£1,278.66	£1,534.39

$\Delta t50$  is the UK's industry standard for heating outputs, which has an operating temperature of 75/65/20°C. If you have a low temperature heat source you may wish to consider  $\Delta t40$  or  $\Delta t30$  output (see your installer or system designer or download from [www.stelrad.com](http://www.stelrad.com)).

**EN 442 CERTIFICATION DATA - CETIAT TESTED IN ACCORDANCE WITH BS EN 442**

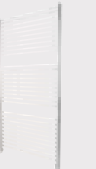

**STRAIGHT**

Type	WHITE				CHROME			
Height (mm)	900	1200	1200	1800	900	1200	1200	1800
Length (mm)	450	450	550	550	450	450	550	550
Btu/hr*t50	1382	1891	2307	3604	1078	1474	1799	2812
Watt* t50	405	554	676	1056	316	432	527	824
Wall to tap centre (mm)	310	310	410	410	310	310	410	410
Centres from wall (mm)	80	80	80	80	80	80	80	80
Max. projection (mm)	100	100	100	100	100	100	100	100
Weight (kg/m)	6	8	9	14	6	8	9	14
Water contents (l/m)	1.79	2.46	2.79	4.3	1.79	2.46	2.79	4.30
Element watt	350	650	650	900	350	350	350	900

**EN 442 CERTIFICATION DATA - CETIAT TESTED IN ACCORDANCE WITH BS EN 442**

**CURVED**

Type	WHITE				CHROME			
Height (mm)	900	1200	1500	1800	900	1200	1500	1800
Length (mm)	550	550	550	550	550	550	550	550
Btu/hr*t50	1679	2307	2935	3604	1311	1799	2290	2812
Watt* t50	492	676	860	1056	384	527	671	824
Wall to tap centre (mm)	410	410	410	410	410	410	410	410
Centres from wall (mm)	40	40	40	40	40	40	40	40
Max. projection (mm)	75	75	75	75	75	75	75	75
Weight (kg/m)	6	9	11	14	6	9	11	14
Water contents (l/m)	2.03	2.79	3.54	4.3	2.03	2.79	3.54	4.3
Element watt	350	650	900	900	350	350	650	900

ESPRIT STRAIGHT

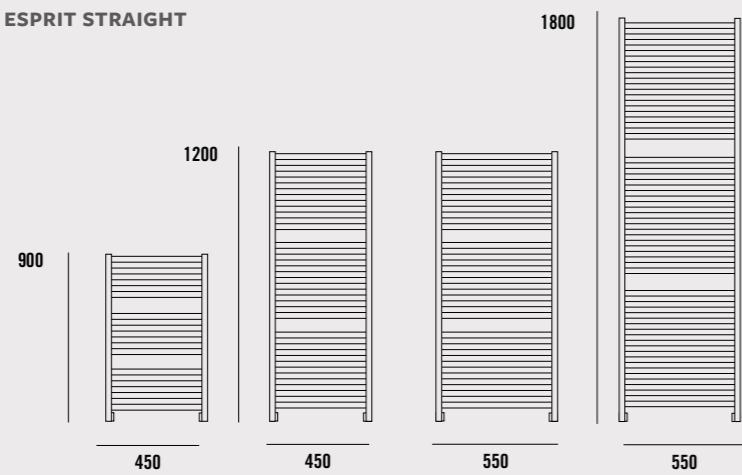

ESPRIT CURVED

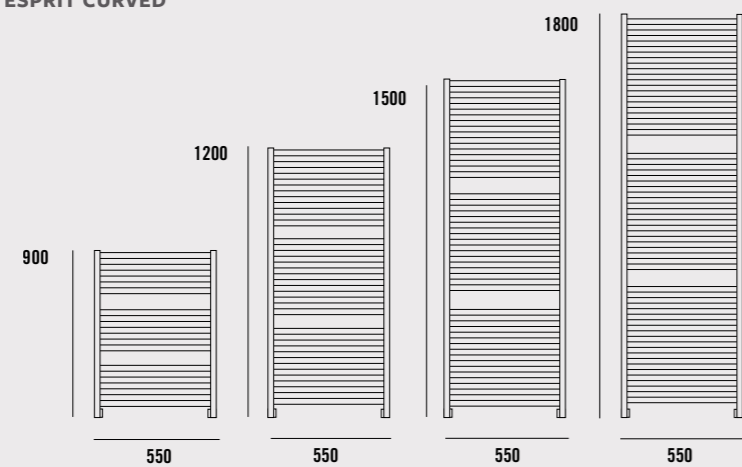

BRACKET POSITIONS FOR STRAIGHT AND CURVED

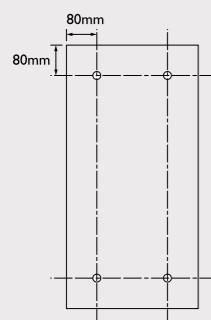

ELECTRIC ELEMENT OPTION FOR STRAIGHT AND CURVED

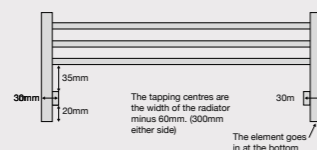

BRACKET ASSEMBLY FOR STRAIGHT AND CURVED

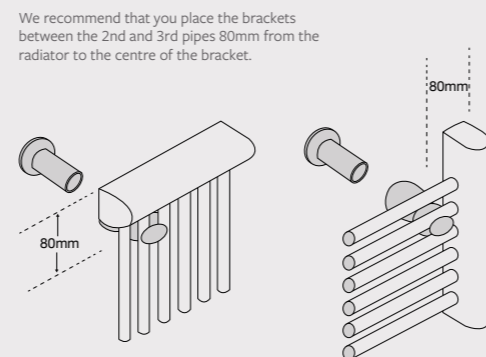

CONNECTIONS

Each radiator comes with 1/2" inlet connections as standard.

50 Δt  
(75/65/20°C)

VERTICAL ULTRA

Front Panel Height mm	Emitter Height mm	Front Panel Length mm	Emitter Length mm	Stelrad UIN	Heat output Watts	Btu/hr	Price excl VAT	Price incl VAT	Towel Rail Bar	Stelrad UIN	Price excl VAT	Price incl VAT
1040	1000	470	400	86110224	857	2924	£396.40	£475.68	400mm wide	83200004	£58.25	£69.90
		570	500	86110225	1071	3654	£427.15	£512.58	500mm wide	83200005	£63.39	£76.07
		670	600	86110226	1285	4384	£496.17	£595.40	600mm wide	83200006	£68.63	£82.36
1240	1200	470	400	86112224	999	3409	£401.05	£481.26	Towel rail bar is 120mm wider than actual radiator.			
		570	500	86112225	1249	4262	£482.19	£578.63				
		670	600	86112226	1499	5115	£555.67	£666.80				
1840	1800	470	400	86118224	1476	5036	£519.94	£623.93				
		570	500	86118225	1845	6295	£606.59	£727.91				
		670	600	86118226	2214	7554	£675.91	£811.09				
2040	2000	470	400	86120224	1584	5405	£538.98	£646.78				
		570	500	86120225	1980	6756	£622.17	£746.60				
		670	600	86120226	2376	8107	£684.74	£821.69				

Please refer to radiator height and length when ordering.

Δt50 is the UK's industry standard for heating outputs, which has an operating temperature of 75/65/20°C. If you have a low temperature heat source you may wish to consider Δt40 or Δt30 output (see your installer or system designer or download from www.stelrad.com).

This is a bespoke made to order radiator which is also available in 36 colours, see the colour options on page 304. All bespoke and coloured radiators have a lead time of up to 8 weeks from date of purchase.

NB: When choosing a colour only the front fascia panel can be coloured. Where the product is 1000mm and 1200mm, the emitter, top grille and side panels are black. If the product is 1800mm and 2000mm, the emitter, top grille and side panels are white. When a coloured radiator or radiators have been ordered, they cannot be cancelled or returned.

EN 442 CERTIFICATION DATA - CETIAT TESTED IN ACCORDANCE WITH BS EN 442

Type	T22 (K2)			
Height (mm)	1000	1200	1800	2000
W/m at 75/65/20	2142	2498	3690	3960
n-coefficients	1.29	1.30	1.33	1.33
Heated surface area (m²/m)	26.23	27.15	29.90	37.74
Weight (kg/m)	59.40	71.80	105.30	116.40
Water contents (l/m)	10.30	12.30	15.90	17.70
KM	13.62	15.66	20.70	21.98

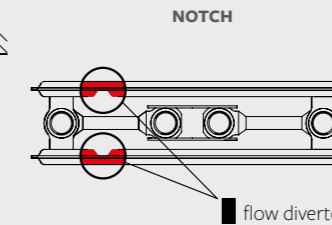
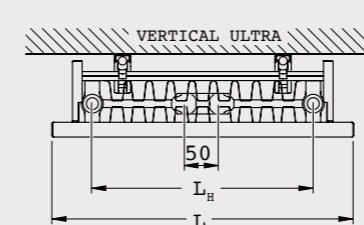

CONNECTIONS

Each radiator comes with 1/2" inlet connections as standard.

CONNECTIONS

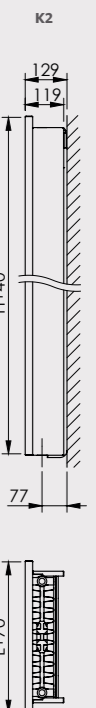
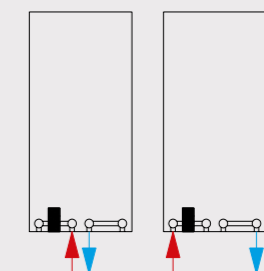

TABLE OF HEAT OUTPUTS AT:

Inlet	75°C	Watt to Btu/hr:
Outlet	65°C	3.412
Ambient	20°C	3.412
Delta T	50°C	3.412



**50 Δt**  
(75/65/20°C)

**WALL MOUNTED**

Height mm	Length mm	Max Projection mm	Stelrad UIN	Heat output Watts	Heat output Btu/hr	Price excl VAT	Price incl VAT
<b>1800</b>	380	60	147040	727	2481	£618.63	£742.36
	500	60	147075	957	3266	£712.33	£854.80
<b>2000</b>	500	60	147110	1048	3577	£774.30	£929.16

Δt50 is the UK's industry standard for heating outputs, which has an operating temperature of 75/65/20°C. If you have a low temperature heat source you may wish to consider Δt40 or Δt30 output (see your installer or system designer or download from [www.stelrad.com](http://www.stelrad.com)).

**EN 442 CERTIFICATION DATA - CETIAT TESTED IN ACCORDANCE WITH BS EN 442**

Type	Wall Mounted		
Height	1800	1800	2000
Length	380	500	500
Btu/hr	2481	3167	3577
Watts	727	957	1048
Tapping centres (mm)	340	460	460
Centres from wall (mm)	42	42	42
Max. projection (mm)	60	60	60
Weight (kg/m)	10	13	14
Water contents (l/m)	1.83	2.41	2.68

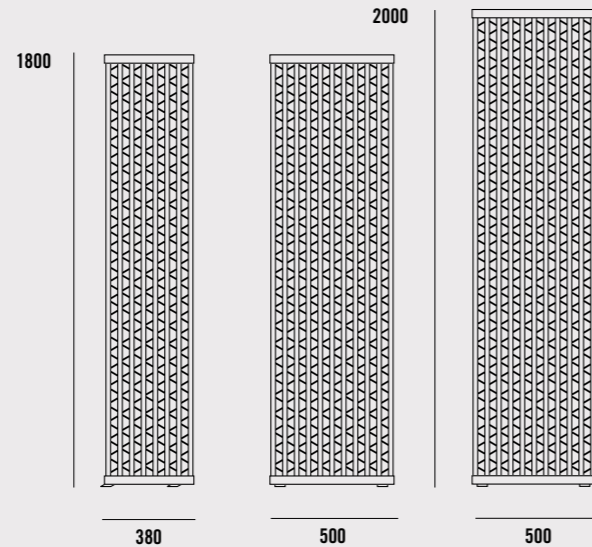

**BRACKETS POSITION**

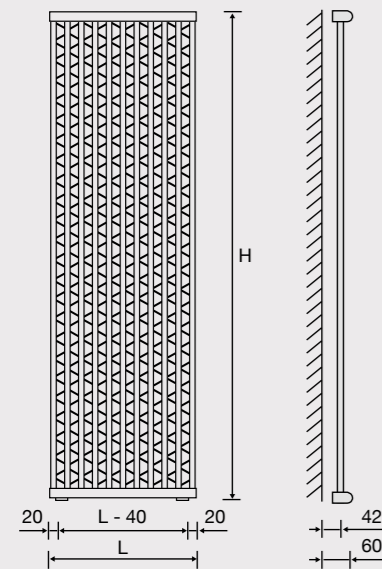
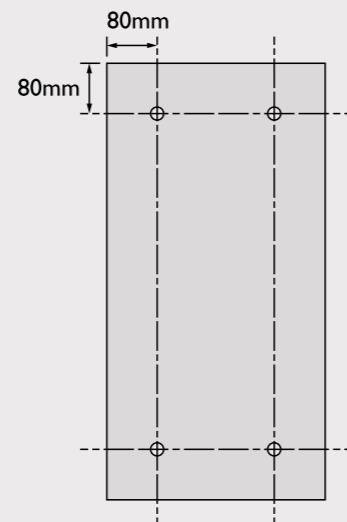

All dimensions in mm.

**CONNECTIONS**

Each radiator comes with 1/2" inlet connections as standard.

**50 Δt**  
(75/65/20°C)

**ARC**

Height mm	Length mm	Max Projection mm	Stelrad UIN	Watts	Heat output Btu/hr	Price excl VAT	Price incl VAT
<b>1800</b>	380	200	147037	882	3010	£485.95	£583.14
	440	200	147038	1021	3485	£509.95	£611.94
	620	200	147039	1438	4908	£634.38	£761.26

**WAVE**

Height mm	Length mm	Max Projection mm	Stelrad UIN	Watts	Heat output Btu/hr	Price excl VAT	Price incl VAT
<b>1800</b>	380	200	147034	882	3010	£542.18	£650.62
	440	200	147035	1021	3485	£572.93	£687.52
	620	200	147036	1438	4908	£697.38	£836.86

Δt50 is the UK's industry standard for heating outputs, which has an operating temperature of 75/65/20°C. If you have a low temperature heat source you may wish to consider Δt40 or Δt30 output (see your installer or system designer or download from [www.stelrad.com](http://www.stelrad.com)).

**EN 442 CERTIFICATION DATA - CETIAT TESTED IN ACCORDANCE WITH BS EN 442**

Type	Arc			Wave		
Height	1800	1800	1800	1800	1800	1800
Length	380	440	620	380	440	620
Btu/hr	3010	3484	4908	2481	3167	3577
Watts	882	1021	1438	727	957	1048
Tapping centres (mm)	340	400	580	340	460	460
Centres from wall (mm)	42	42	42	60	60	60
Max. projection (mm)	200	200	200	120	120	120
Weight (kg/m)	10	13	14	10	13	14
Water contents (l/m)	3.05	3.52	4.97	3.05	3.52	4.97

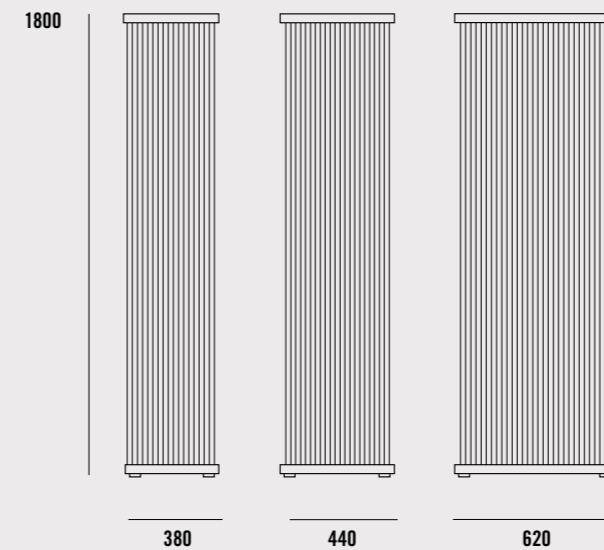

All dimensions in mm.

**BRACKETS POSITION**

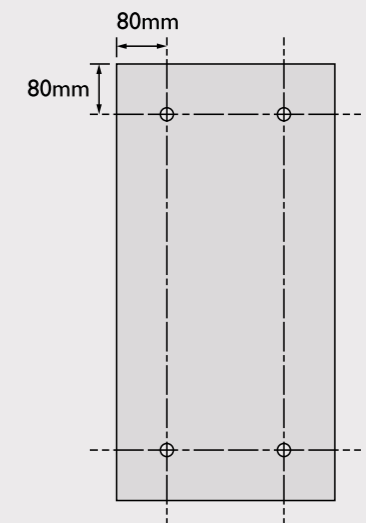

**CONNECTIONS**

Each radiator comes with 1/2" inlet connections as standard.

**50 Δt**  
(75/65/20°C)

**SINGLE ROW**

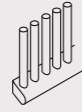

Height mm	Length mm	Max Projection mm	Stelrad UIN	Heat output		Price excl VAT	Price incl VAT
				Watts	Btu/hr		
1800	320	60	147250	742	2532	£281.28	£337.54
	440	60	147285	1021	3485	£320.40	£384.48
	620	60	147320	1438	4908	£414.78	£497.74
2000	500	60	147355	1275	4352	£369.88	£443.86
	620	60	147390	1580	5393	£449.14	£538.97
	740	60	147425	1886	6437	£529.19	£635.03

**DOUBLE OFFSET ROW**

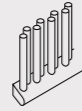

Height mm	Length mm	Max Projection mm	Stelrad UIN	Heat output		Price excl VAT	Price incl VAT
				Watts	Btu/hr		
1800	320	60	147460	818	2792	£354.28	£425.14
	440	60	147495	1130	3857	£422.65	£507.18
	620	60	147530	1597	5451	£566.83	£680.20
2000	500	60	147565	1415	4829	£506.48	£607.78
	620	60	147600	1758	6000	£615.83	£739.00

Δt50 is the UK's industry standard for heating outputs, which has an operating temperature of 75/65/20°C. If you have a low temperature heat source you may wish to consider Δt40 or Δt30 output (see your installer or system designer or download from [www.stelrad.com](http://www.stelrad.com)).

For further assistance on colour option UINs and prices, please contact the sales admin team on 0844 543 6200.

**EN 442 CERTIFICATION DATA - CETIAT TESTED IN ACCORDANCE WITH BS EN 442**

Type	Single Row						Double Offset Row				
	1800	1800	1800	2000	2000	2000	1800	1800	1800	2000	2000
Height	1800	1800	1800	2000	2000	2000	1800	1800	1800	2000	2000
Length	320	440	620	500	620	740	320	440	620	500	620
Btu/hr	2532	3484	4908	4351	5392	6437	2792	3856	5450	4829	6000
Watts	742	1021	1438	1275	1580	1886	818	1130	1597	1415	1758
Tapping centres (mm)	280	280	580	460	580	700	280	400	580	460	580
Centres from wall (mm)	42	42	42	42	42	42	48	48	48	48	48
Max. projection (mm)	60	60	60	60	60	60	66	66	66	66	66
Weight (kg/m)	8	11	16	14	17	17	10	14	20	18	22
Water contents (l/m)	2.57	3.52	4.97	4.41	5.46	6.52	3.22	4.42	6.23	5.54	6.86

**VISTALINE 2 SINGLE ROW**

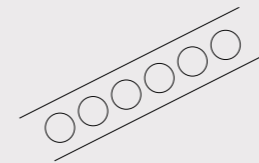

**VISTALINE 3 DOUBLE OFFSET ROW**

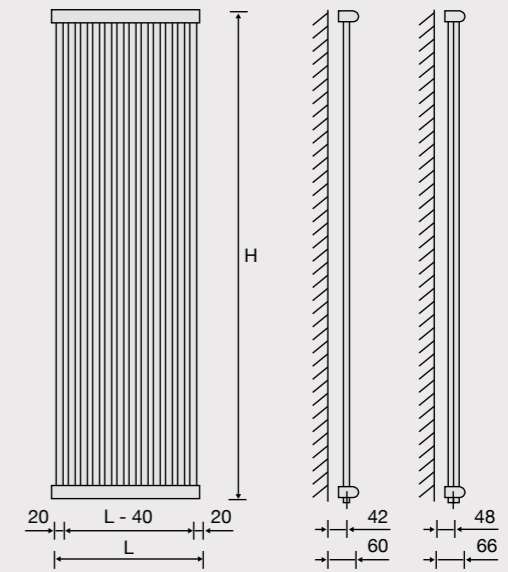
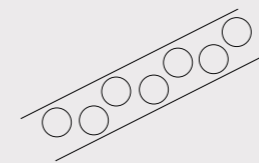

All dimensions in mm.

**BRACKETS POSITION**

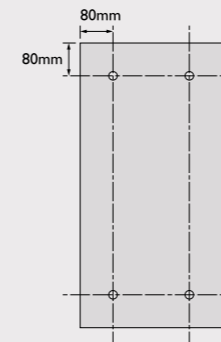

**TAPPING CENTRE FOR THE VISTALINE**

L - 40mm perpendicular to the manifold

H - 22mm (+2mm) In line with the manifold \* coupling protrudes 10mm

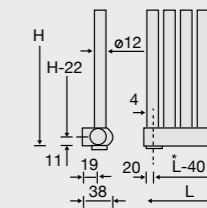

**STANDARD FITTING**

EG  $\frac{1}{2}$ "



**CONNECTIONS**

Each radiator comes with  $\frac{1}{2}$ " inlet connections as standard.

**50  $\Delta t$**   
(75/65/20°C)

**EH**

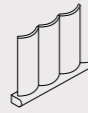

Height mm	Length mm	Max Projection mm	Stelrad UIN	Heat output Watts	Heat output Btu/hr	Price excl VAT	Price incl VAT
<b>1800</b>	459	65	147635	858	2928	£325.18	£390.22
	689	65	147670	1287	4393	£422.18	£506.62
<b>2000</b>	459	65	147705	954	3256	£337.65	£405.18
	689	65	147740	1431	4884	£438.26	£525.91
	765	65	147775	1590	5427	£471.66	£565.99

**EOH**



Height mm	Length mm	Max Projection mm	Stelrad UIN	Heat output Watts	Heat output Btu/hr	Price excl VAT	Price incl VAT
<b>1800</b>	459	65	147810	858	2928	£366.61	£439.93
	689	65	147845	1287	4393	£463.23	£555.88
<b>2000</b>	459	65	147880	954	3256	£379.42	£455.30
	689	65	147915	1431	4884	£480.03	£576.04
	765	65	147950	1590	5427	£512.76	£615.31

$\Delta t50$  is the UK's industry standard for heating outputs, which has an operating temperature of 75/65/20°C. If you have a low temperature heat source you may wish to consider  $\Delta t40$  or  $\Delta t30$  output (see your installer or system designer or download from [www.stelrad.com](http://www.stelrad.com)).

For further assistance on colour option UINs and prices, please contact the sales admin team on 0844 543 6200.

**EN 442 CERTIFICATION DATA - CETIAT TESTED IN ACCORDANCE WITH BS EN 442**

Type	EH					EOH				
	1800	1800	2000	2000	2000	1800	1800	2000	2000	2000
Height	1800	1800	2000	2000	2000	1800	1800	2000	2000	2000
Length	459	689	459	689	765	459	689	459	689	765
Btu/hr	2928	4392	3256	4884	5426	2928	4392	3256	4884	5426
Watts	858	1287	954	1431	1590	858	1287	954	1431	1590
Tapping centres (mm)	419	649	419	649	725	419	649	419	649	725
Centres from wall (mm)	46	46	46	46	46	46	46	46	46	46
Max. projection (mm)	65	65	65	65	65	65	65	65	65	65
Weight (kg/m)	17	22	26	19	29	17	22	26	19	29
Water contents (l/m)	4.60	6.90	5.07	7.61	8.45	4.60	6.90	5.07	7.61	8.45

**ELLIPSE EH INWARD**

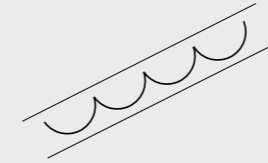

**ELLIPSE EOH ALTERNATE**

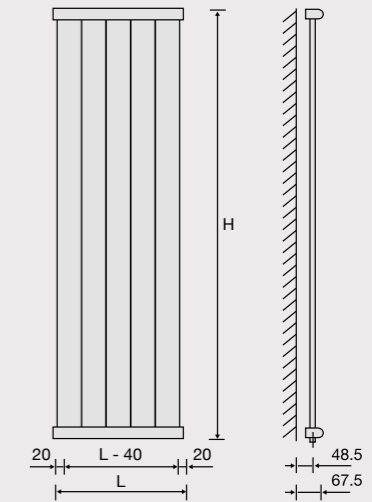
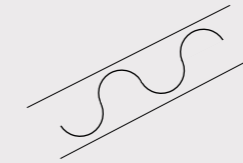

All dimensions in mm.

**BRACKETS POSITION**

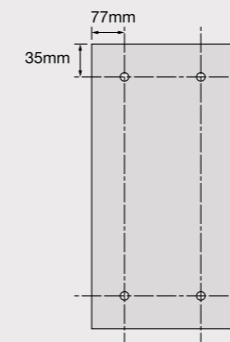

**TAPPING CENTRE FOR THE ELLIPSE**

L - 40mm perpendicular to the manifold

H - 22mm ( $\pm 2$ mm) In line with the manifold \* coupling protrudes 10mm

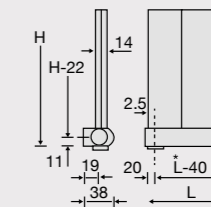

**STANDARD FITTING**

EG  $\phi 1/2"$

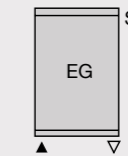

**CONNECTIONS**

Each radiator comes with  $1/2"$  inlet connections as standard.



**50  $\Delta t$**   
(75/65/20°C)

Height mm	Length mm	Max Projection mm	Stelrad UIN	Heat output		Price excl VAT	Price incl VAT
				Watts	Btu/hr		
<b>1800</b>	160	202	147985	742	2532	£859.30	£1,031.16
	200	242	147986	928	3167	£921.43	£1,105.72
	240	282	147987	1114	3802	£981.79	£1,178.15

$\Delta t50$  is the UK's industry standard for heating outputs, which has an operating temperature of 75/65/20°C. If you have a low temperature heat source you may wish to consider  $\Delta t40$  or  $\Delta t30$  output (see your installer or system designer or download from [www.stelrad.com](http://www.stelrad.com)).

**EN 442 CERTIFICATION DATA - CETIAT TESTED IN ACCORDANCE WITH BS EN 442**

Height	1800	1800	1800
Length	160	200	240
Btu/hr	2532	3167	3802
Watts	742	928	1114
Tapping centres (mm)	50	50	50
Centres from wall (mm)	42	42	42
Max. projection (mm)	202	242	282
Weight (kg/m)	9	11	13
Water contents (l/m)	2.51	3.06	3.61



**BRACKETS ASSEMBLY**

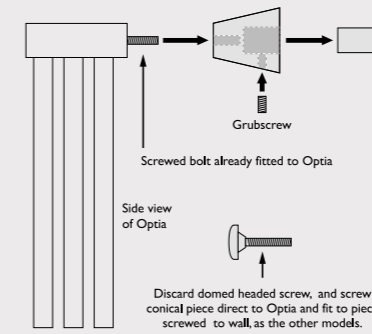

All dimensions in mm.

**BRACKETS POSITIONS**

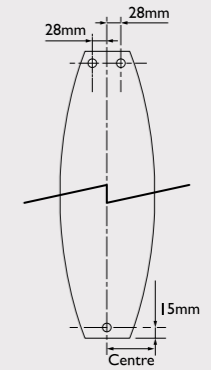

**SIDE VIEW**

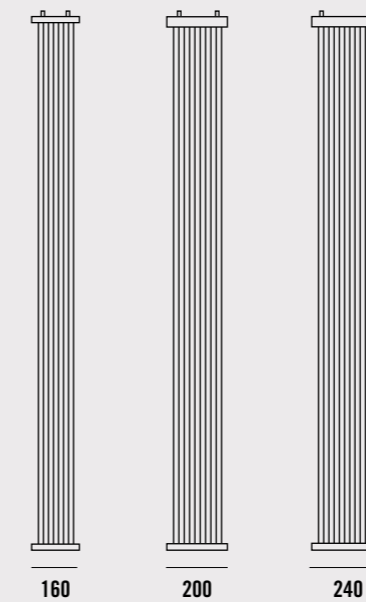

**FRONT VIEW**

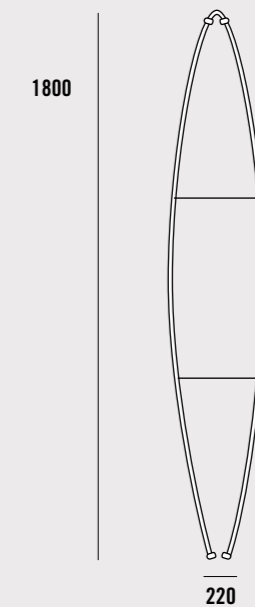

**CONNECTIONS**

Each radiator comes with 1/2" inlet connections as standard.

# Colour Guide

A shade for every room, for every interior. Opt for warm elegance, baroque ambience or modern minimalism.

Colour information for the:  
Aqua Series - Caliente Rail, Caliente Curved Rail, Concord Rail & Vertical Ultra\*

## Natural Colours



## Metallic Colours

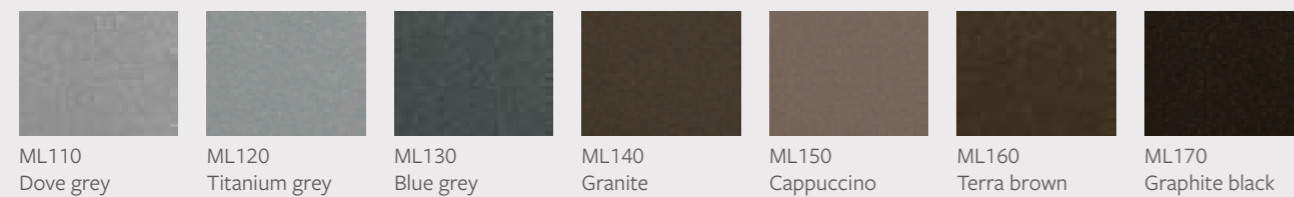

## RAL Colours

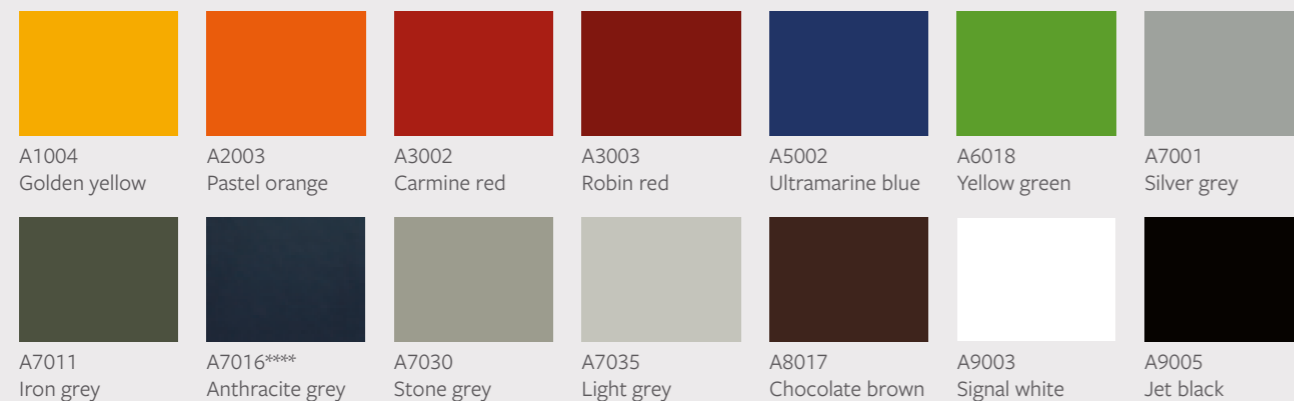

\*Please note: When choosing a colour only the front fascia panel can be coloured. Where the product height is 1000mm and 1200mm, the emitter, top grille and side panels are black. If the product height is 1800mm and 2000mm, the emitter, top grille and side panels are white.



RAL 9016\*\*  
Traffic white  
comes as  
standard on  
all radiators.

Stelrad Radiators are available in white (RAL 9016) as standard, however the specific Radiators identified are now available in a variety of colours.

The colours shown are reproduced as accurately as this process will allow and can be made to order on the identified products.

With Stelrad, you can heat your home in colour.  
Choose from a full range of stylish radiator colours.

Colour information for the:  
Aqua Series - Vistaline and Ellipse

## RAL Colours



## Metallic Colours





For further information on RAL colours  
please visit [www.ralcolor.com](http://www.ralcolor.com)

All colour radiators have up to an 8 week lead time, and when a coloured radiator or radiators have been ordered they cannot be cancelled or returned.











To request a colour chart please email [marketing@stelrad.com](mailto:marketing@stelrad.com)

Where indicated products are only available in this colour: \*Excel \*\*Standard white \*\*\*Arc, Wave, Optia.

# Glossary

Btu/hr	British Thermal Unit per hour is the standard measurement used to state the amount of output of any heat generating device.
Watts	Is another measurement for heat output, 1 watt is equivalent to 3.412 Btu/hr.
P1	Also known as Type 10, is a type of radiator with 1 radiator panel and no convection fins.
K1	Also known as Type 11, is a type of radiator with 1 radiator panel and 1 set of convection fins.
P+	Also known as Type 21, is a type of radiator with 2 radiator panels and 1 set of convection fins.
K2	Also known as Type 22, is a type of radiator with 2 radiator panels and 2 sets of convection fins.
K3	Also known as Type 33, is a type of radiator with 3 radiator panels and 3 sets of convection fins.
$\Delta t$	Refers to the difference in temperature between the water circulating in the central heating system and that of the ambient temperature. It is important to use the correct $\Delta t$ when selecting your radiators, as the same radiator will have different outputs at different water temperatures.
$\Delta t_{50}$	$\Delta t_{50}$ is the UK standard, however Stelrad also quote at lower levels for lower water temperature systems.
Heat loss	Is the amount of heat a room loses, it is therefore an important calculation when determining what size radiator is required to heat a room to the correct level.
UIN	Is the unique identification number for Stelrad products.
Warranty	The warranty covers any defect that is attributable to a manufacturing, assembly or material fault. Further details available on request.
ISO14001	Is a set of International regulations related to the environment.
ISO9001	Is a set of International regulations related to quality management systems.
OHSAS18001	Is a set of International regulations related to health and safety.
TBOE / BOE	Refers to which position the pipes are connected to the radiator, OE means opposite end i.e. 1 pipe on each side, TB is top bottom i.e. 1 pipe is connected to the top and 1 to the bottom, B is both pipes connected to the bottom.
CETIAT tested	A leading independent French laboratory which conducts testing and assessments.
 EN 442	EN 442 is the European standard which defines the manufacturing standards for radiators and convectors which operate at temperatures of less than 120°C. The standard defines the type of steel which must be used, the type of pressure testing which must be carried out and the accuracy of the heat outputs quoted in the literature.
 STARS	The Stelrad Technically Advanced Radiator System heatloss calculator, offers an even simpler way to get sizing of radiators right, first time. Visit <a href="http://www.starsapp.co.uk">www.starsapp.co.uk</a>
KIWA	Kiwa Ltd is an energy consultancy, Notified Body, UKAS-accredited testing lab and training centre with expertise in gas, oil, solid fuel, biomass and other renewables, construction materials, water and electricity.
RAL	A European wide colour matching system.
BSP	British Standard Piping.

# Icon Key

	2 year warranty that covers any defect that is attributable to a manufacturing, assembly or material fault. Further details available on request.		Business Information Modelling. Visit <a href="http://www.stelrad.com">www.stelrad.com</a> to download BIM components.
	5 year warranty that covers any defect that is attributable to a manufacturing, assembly or material fault. Further details available on request.		Market leading prices from your market leader.
	10 year warranty that covers any defect that is attributable to a manufacturing, assembly or material fault. Further details available on request.		Outstanding energy efficient radiators with the ability to reduce your bills by up to 10.5%.
	15 year warranty that covers any defect that is attributable to a manufacturing, assembly or material fault. Further details available on request.		Award winning radiators from Stelrad, the UK's number one radiator brand.
	Continuing Professional Development. CIBSE (Chartered Institute of British Service Engineers) and RIBA (Royal Institute of British Architects). CPD approved courses available.		All colour radiators have up to an 8 week lead time.
	All radiators with this logo are made to order. Made to order radiators cannot be cancelled or returned once ordered.		

# Corporate Social Responsibility (CSR)

Stelrad recognises that its success is built on integrating business values and operations to meet the expectations of stakeholders. Stelrad's social, economic and environmental responsibilities are to these stakeholders, which are demonstrated throughout its business practises, policies and achievements. Stelrad are committed to Integrated Management Systems for control of Quality, Health and Safety and Environment, which are certificated to BSI OHSAS / ISO standards.

Wherever possible, Stelrad sources renewable and recyclable materials. 100% of all metal and other raw materials throughout the manufacturing process are recycled.

A full CSR policy document is available on request.



To re-order this brochure, call sales admin on 0844 543 6200 and quote UIN: 208904



*Follow us on*



@stelrad



facebook.com/  
stelradradiators



pinterest.com/  
stelrad

*Stelrad Limited, Stelrad House, Marriott Road  
Mexborough, South Yorkshire, S64 8BN*

**[www.stelrad.com](http://www.stelrad.com)**

Telephone: 0844 543 6200

UIN 208904  
AS/2K/0717

