

50 Δt

(75/65/20°C)

K1



K2



Height mm	Length mm	Stelrad UIN	Heat output		Price excl VAT	Price incl VAT	Stelrad UIN	Heat output		Price excl VAT	Price incl VAT
			Watts	Btu/h				Watts	Btu/h		
300	500	82301105	235	802	£35.96	£43.15	82302205	465	1587	£53.60	£64.32
	1000	82301110	469	1601	£58.68	£70.42	82302210	929	3171	£93.26	£111.91
	1500	82301115	704	2401	£83.46	£100.15	82302215	1394	4756	£143.27	£171.92
450	400	82451104	268	915	£36.70	£44.04	82452204	500	1705	£58.33	£70.00
	600	82451106	403	1376	£42.83	£51.40	82452206	750	2559	£74.99	£89.99
	800	82451108	537	1834	£57.09	£68.51	82452208	999	3410	£86.64	£103.97
	1000	82451110	672	2292	£71.36	£85.63	82452210	1249	4262	£99.96	£119.95
	1200	82451112	806	2751	£85.63	£102.76	82452212	1499	5114	£119.98	£143.98
	1400	82451114	941	3209	£99.93	£119.92	82452214	1749	5967	£154.56	£185.47
	1600	82451116	1075	3668	£114.20	£137.04	82452216	1999	6819	£176.63	£211.96
	1800	82451118	1209	4126	£139.48	£167.38	82452218	2248	7672	£198.72	£238.46
600	400	82601104	348	1188	£40.02	£48.02	82602204	640	2184	£63.63	£76.36
	600	82601106	522	1782	£46.72	£56.06	82602206	961	3280	£81.80	£98.16
	800	82601108	696	2375	£62.28	£74.74	82602208	1281	4372	£94.54	£113.45
	1000	82601110	870	2969	£77.86	£93.43	82602210	1601	5464	£109.08	£130.90
	1200	82601112	1044	3563	£93.42	£112.10	82602212	1921	6556	£130.88	£157.06
	1400	82601114	1218	4157	£109.00	£130.80	82602214	2242	7649	£168.61	£202.33
	1600	82601116	1392	4751	£124.57	£149.48	82602216	2563	8744	£192.70	£231.24
	1800	82601118	1566	5345	£152.15	£182.58	82602218	2883	9836	£216.76	£260.11
	2000	82601120	1740	5939	£156.08	£187.30	82602220	3203	10928	£331.77	£398.12

Δt 50 is the UK's industry standard for heating outputs, which has an operating temperature of 75/65/20°C. If you have a low temperature heat source you may wish to consider Δt 40 or Δt 30 output (see your installer or system designer or download from www.stelrad.com).

For EN442 data, technical and installation information please visit our website: www.stelrad.com and search product downloads.

See how a Stelrad Vita Deco is manufactured at www.stelrad.com

WALL MOUNTING AND LUG INFORMATION

All dimensions in mm. Inches in brackets.

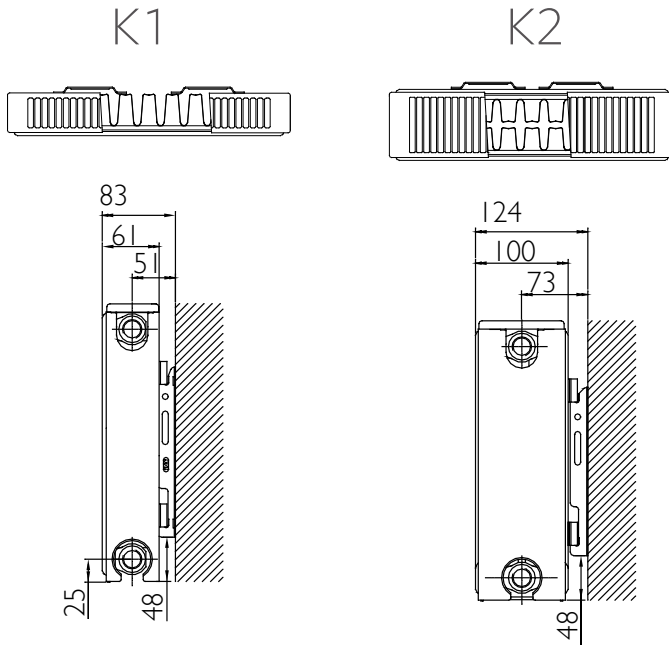

MOUNTING BRACKETS

All dimensions in mm. Inches in brackets. Floor mounting brackets available.

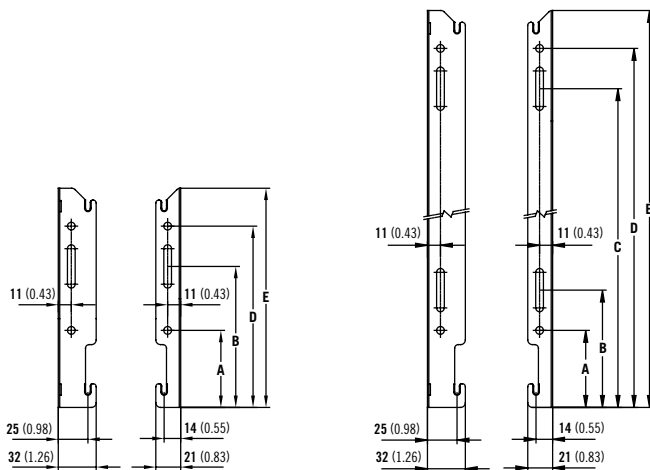

Dimensions	mm	inches	mm	inches	mm	inches
Height	300	11.81	450	17.72	600	23.62
A	65	2.56	65	2.56	65	2.56
B	119	4.69	99	3.90	99	3.90
C	-	-	269	10.59	419	16.50
D	153	6.02	303	11.93	453	17.83
E	185	7.28	335	13.19	485	19.09

K1 & K2 LUG POSITIONS (New as of June 2016).

All dimensions in mm. Inches in brackets.

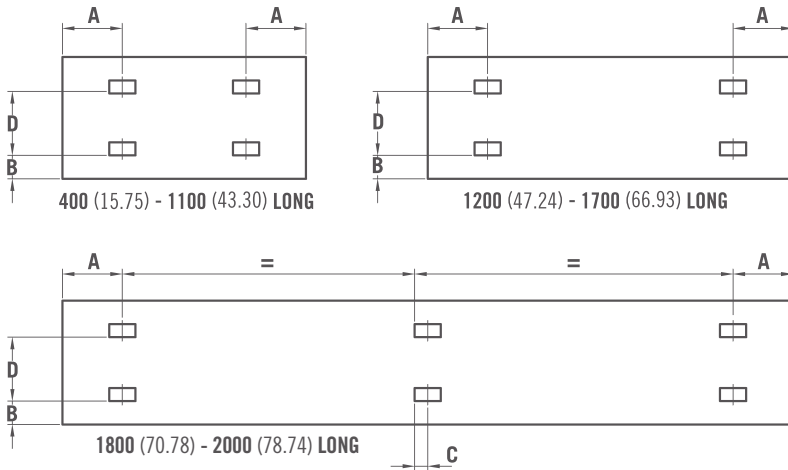

PANEL HEIGHT				K1		K2		
mm	in	mm	in	mm	in	mm	in	
300	11.81	155	6.10	A 400mm	117	4.61	133	5.24
450	17.72	305	12.01	A 500 - 2000mm	150	5.91	133	5.24
600	23.62	455	17.91	B 400 - 2000mm	60	2.36	60	2.36
700	27.56	555	21.95	C 1800 - 2000mm	17	0.67	L/2	L/2

L/2 is the length divided by two.

CONNECTIONS

Each radiator comes with 1/2" inlet connections as standard.

PIPING OPTIONS

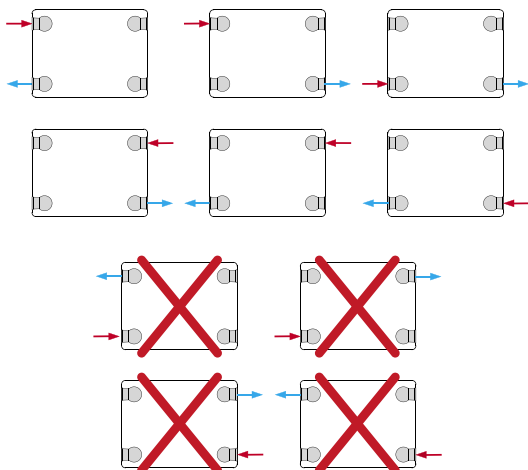

PRESSURE DROP

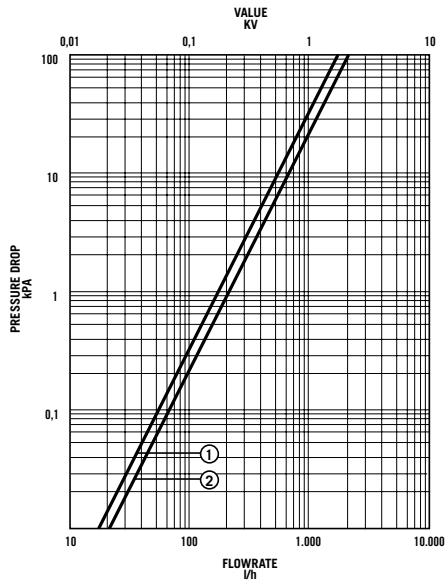

- ① Type 11 (K1)
- ② Type 22 (K2)