



# VITA COMPACT K3

Vita Series

**50  $\Delta t$**

(75/65/20°C)

**K3**



Height mm	Length mm	Stelrad UIN	Watts	Heat output Btu/hr
<b>300</b>	1000	76303310	1349	4603
	2000	76303320	2698	9206
<b>500</b>	600	76503306	1234	4210
	700	76503307	1439	4910
	800	76503308	1645	5613
	900	76503309	1850	6312
	1000	76503310	2056	7015
	1100	76503311	2262	7718
	1200	76503312	2467	8417
	1400	76503314	2878	9820
	1600	76503316	3290	11225
	1800	76503318	3701	12628
	2000	76503320	4112	14030
2400	76503324	4934	16835	
<b>600</b>	400	76603304	956	3262
	500	76603305	1195	4077
	600	76603306	1433	4889
	700	76603307	1672	5705
	800	76603308	1911	6520
	900	76603309	2150	7336
	1000	76603310	2389	8151
	1100	76603311	2628	8967
	1200	76603312	2867	9782
	1400	76603314	3345	11413
	1600	76603316	3822	13,041
	1800	76603318	4300	14,72
	2000	76603320	4778	16303
2400	76603324	5734	19564	
<b>700</b>	500	76703305	1356	4627
	600	76703306	1627	5551
	700	76703307	1898	6476
	800	76703308	2170	7404
	900	76703309	2441	8329
	1000	76703310	2712	9253
	1100	76703311	2983	10178
	1200	76703312	3254	11103
	1400	76703314	3797	12955
	1600	76703316	4339	14805
	1800	76703318	4882	16657
2000	76703320	5424	18507	

$\Delta t$ 50 is the UK's industry standard for heating outputs, which has an operating temperature of 75/65/20°C. If you have a low temperature heat source you may wish to consider  $\Delta t$ 40 or  $\Delta t$ 30 output (see your installer or system designer or download from [www.stelrad.com](http://www.stelrad.com)).

For EN442 data, technical and installation information please visit our website: [www.stelrad.com](http://www.stelrad.com) and search product downloads.

# VITA COMPACT K3

Vita Series

## WALL MOUNTING AND LUG INFORMATION

All dimensions in mm. Inches in brackets.

REAR ELEVATION

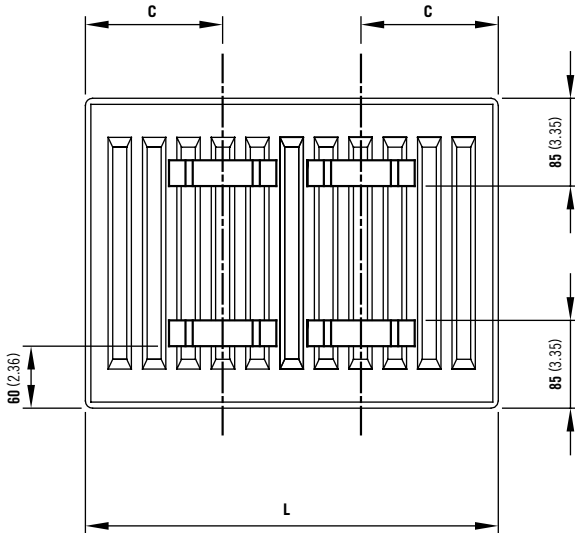

SIDE ELEVATION

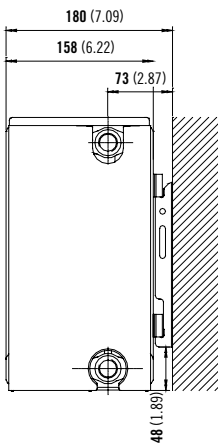

TOP ELEVATION

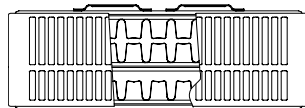

L	C
400 - 1100	133
1200 - 2400	133

# VITA COMPACT K3

Vita Series

## FLOORSTANDING BRACKETS

All dimensions in mm. Inches in brackets.

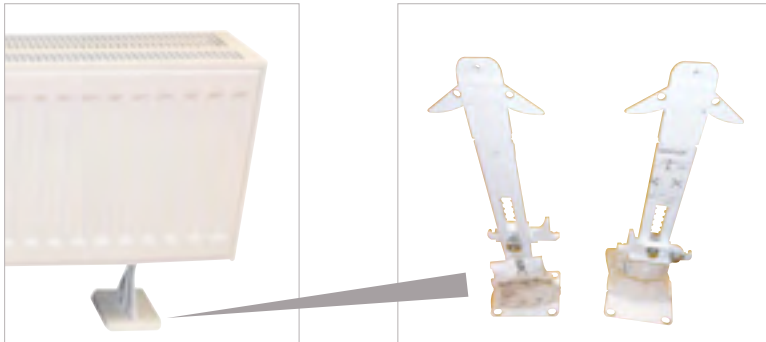

Floor brackets

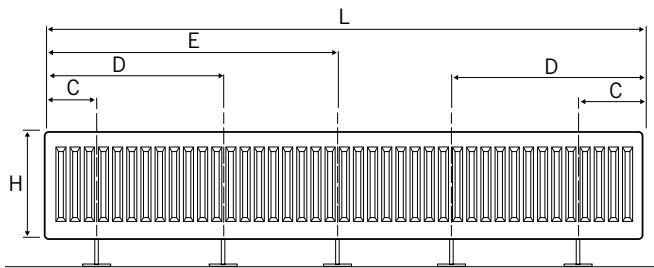
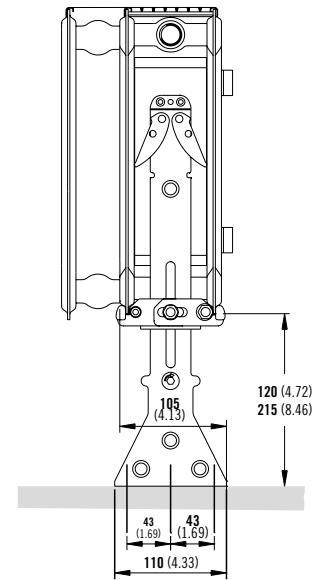

	<b>L</b>	400	500 - 1100	1200	1400 - 1800	2000 - 3000
<b>H</b>	Number	2pc				3pc
300	<b>C</b>	117	150	250	250	250
500	<b>E</b>	-	-	-	-	L/2+17

	<b>L</b>	400	500 - 1100	1200	1400 - 1800	2000	2200	2400	2600	2800	3000
<b>H</b>	Number	2pc			3pc	4pc			5pc		
600	<b>C</b>	117	150	250	250	250			250		
700	<b>D</b>	-	-	-	-	750	817	850	750	817	850
	<b>E</b>	-	-	-	817	-	-	-	L/2+17		

## CONNECTIONS

Each radiator comes with 1/2" inlet connections as standard.

## EN 442 CERTIFICATION DATA - CETIAT TESTED IN ACCORDANCE WITH BS EN 442

Type	<b>K3</b>
Height	600
W/m at 75/65/20	2389
n-coefficients	1.32
Heated surface area (m2/m)	11.61
Weight (kg/m)	52.50
Water contents (l/m)	9.80
Wall to tap centre (mm)	73

# VITA COMPACT K3

Vita Series

## PRESSURE DROPS

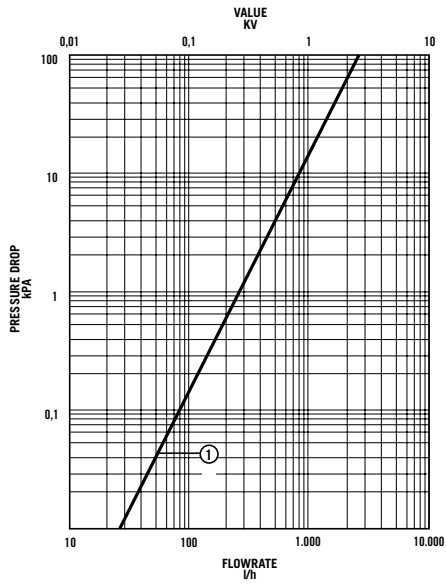

① Type 33 (K3)