

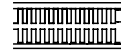

**50  $\Delta t$**

(75/65/20°C)

**DOUBLE**



Height mm	Length mm	Elements	Stelrad UIN	Watts	Heat output Btu/hr
<b>148</b>	800	2	148308	541	1846
	1000	2	148309	676	2307
	1200	2	148310	811	2767
	1400	2	148311	946	3228
	1600	2	148312	1082	3692
	1800	2	148313	1217	4153
	2000	2	148314	1352	4613
	2200	2	148315	1487	5074
<b>296</b>	800	4	148316	892	3044
	1000	4	148317	1115	3805
	1200	4	148318	1338	4565
	1400	4	148319	1561	5326
	1600	4	148320	1784	6087
	1800	4	148321	2007	6848
	2000	4	148322	2230	7609
	2200	4	148323	2453	8370

$\Delta t$ 50 is the UK's industry standard for heating outputs, which has an operating temperature of 75/65/20°C. If you have a low temperature heat source you may wish to consider  $\Delta t$ 40 or  $\Delta t$ 30 output (see your installer or system designer or download from [www.stelrad.com](http://www.stelrad.com)).

For EN442 data, technical and installation information please visit our website: [www.stelrad.com](http://www.stelrad.com) and search product downloads.

If feet are required, they must be ordered when you purchase your product. The feet are welded on and can not be added to the product once your order has been placed.

Optional extra to have no lugs. This needs specifying at the time of ordering. For floorstanding only.

**FLOOR MOUNTING BRACKET INFORMATION**

400 - 1400mm	2 feet
1600 - 2200mm	3 feet

# CONCORD LO-LINE

Designer Series

## WALL MOUNTING INFORMATION

All dimensions in mm.

Type	From back of radiator to wall		From wall to centre of connections		From front of radiator to wall	
	mm	inch	mm	inch	mm	inch
Lo-line	25	0.98	97	3.81	125	4.92

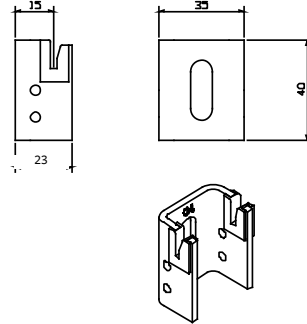

## FLOOR MOUNTING POSITIONS

All dimensions in mm. Inches in brackets. Must be specified at time of ordering as they are securely welded during manufacture.

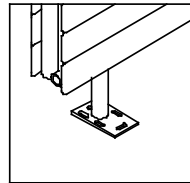
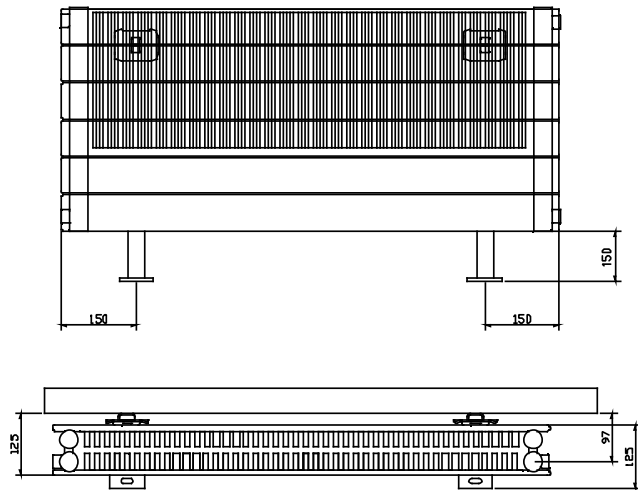

### LO-LINE FIXING POSITIONS

All dimensions in mm. Inches in brackets.

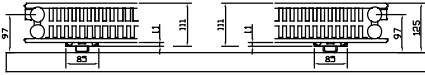

3 brackets 800 to 1400

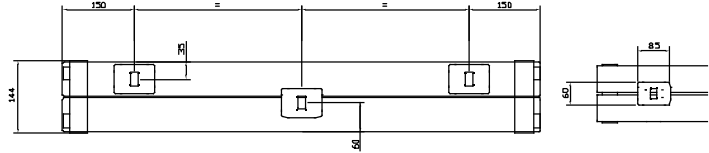

4 brackets 800 to 1400

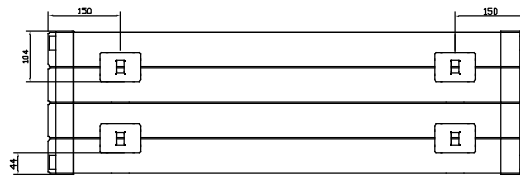

6 brackets 1600 to 2200

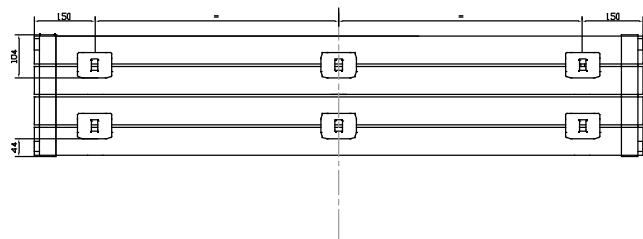

### CONNECTIONS

Each radiator comes with 1/2" inlet connections as standard.

### PIPING INSTRUCTIONS

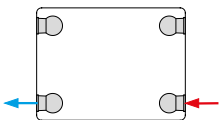
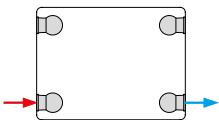

### EN 442 CERTIFICATION DATA - CETIAT TESTED IN ACCORDANCE WITH BS EN 442

Type	Lo-Line	
Height	148	296
W/m at 75/65/20	676	1115
n-coefficients	1.25	1.28
Heated surface area (m <sup>2</sup> /m)	2.51	5.19
Weight (kg/m)	13.30	21.20
Water contents (l/m)	3.10	5.30
Wall to tap centre (mm)	98	98

STEEL THICKNESS 1.25mm

### PRESSURE DROPS

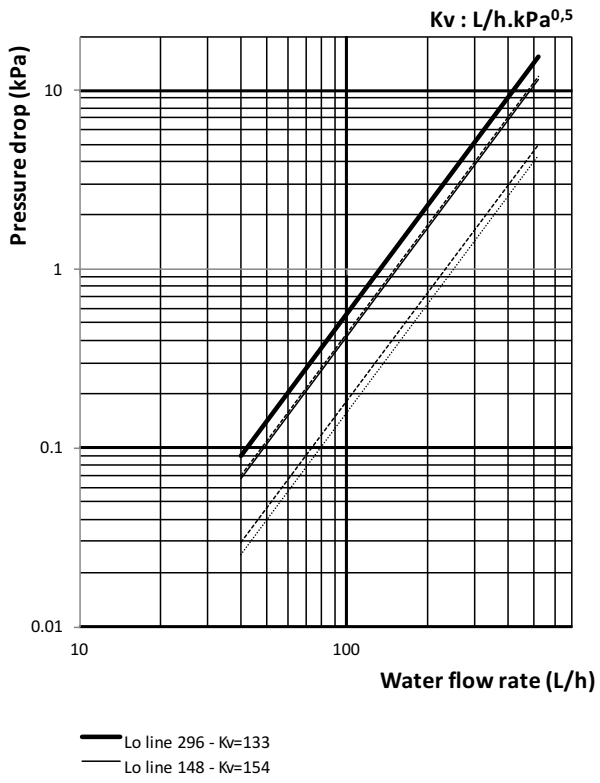

# COLOUR GUIDE

## RAL COLOURS

						
RAL 7035 Pale grey	RAL 7038 Agate grey	RAL 7036 Platinum grey	RAL 7030 Stone grey	RAL 7037 Dusty grey	RAL 7015 Slate grey	RAL 9005* Jet black
						
RAL 8017 Chocolate brown	RAL 1016 Sulphur yellow	RAL 1021 Cadmium yellow	RAL 1004 Dark Golden yellow	RAL 2008 Light red orange	RAL 3000 Flame red	RAL 3003 Ruby red
						
RAL 3005 Wine red	RAL 6027 Light green	RAL 6034 Pastel turquoise	RAL 6019 Pastel green	RAL 6033 Turquoise blue	RAL 6020 Chrome green	RAL 6005 Light moss green
						
RAL 5014 Pigeon blue	RAL 5002 Ultramarine blue	RAL 5024 Pastel blue	RAL 5022 Night blue	RAL 5010 Gentian blue	RAL 9016** Traffic white	RAL 9010 Pure white
						
RAL 9001 Cream	RAL 1013 Pearl white	RAL 1015 Light ivory	RAL 9002 Grey white			

## Metallic Colours

		
BR002 Metallic silver	BR 0004 Gilded aluminium	BR 0007 Satin metal grey

FOR FURTHER INFORMATION ON RAL COLOURS PLEASE VISIT [WWW.RALCOLOR.COM](http://WWW.RALCOLOR.COM)



RAL 9016\*\*  
Traffic white  
comes as  
standard on  
all radiators.

Stelrad Radiators are available in white (RAL 9016) as standard, however the specific Radiators identified are now available in a variety of colours. The colours shown are reproduced as accurately as this process will allow and can be made to order on the identified products.

All colour radiators have up to an 8 week lead time, and when a coloured radiator or radiators have been ordered they cannot be cancelled or returned.

To request a colour chart please email  
[marketing@stelrad.com](mailto:marketing@stelrad.com)