

HOME

SERIES



Column
Horizontal
Coloured

COLUMN HORIZONTAL COLOURED

50 Δ t

(75/65/20°C)

Height mm	Length mm	2 COLUMN			3 COLUMN			4 COLUMN		
		Stelrad UIN	Heat output Watts	Heat output Btu/hr	Stelrad UIN	Heat output Watts	Heat output Btu/hr	Stelrad UIN	Heat output Watts	Heat output Btu/hr
300	444	-	-	-	163000h	288	983	163007h	377	1,287
	628	-	-	-	163001h	416	1,420	163008h	545	1,860
	858	-	-	-	163002h	576	1,966	163009h	754	2,573
	1042	-	-	-	163003h	704	2,403	163010h	922	3,147
	1272	-	-	-	163004h	864	2,949	163011h	1,131	3,860
	1456	-	-	-	163005h	992	3,386	-	-	-
	1870	-	-	-	163006h	1,280	4,369	-	-	-
500	444	163012h	499	1,703	163016h	464	1,584	163023h	608	2,075
	628	163013h	691	2,358	163017h	671	2,290	163024h	879	3,000
	858	163014h	845	2,884	163018h	929	3,171	163025h	1,217	4,154
	1042	163015h	1,037	3,539	163019h	1,135	3,874	163026h	1,487	5,075
	1272	-	-	-	163020h	1,393	4,754	163027h	1,825	6,229
	1456	-	-	-	163021h	1,600	5,461	-	-	-
	1870	-	-	-	163022h	2,064	7,044	-	-	-
600	444	-	-	-	163032h	548	1,870	163039h	718	2,451
	628	163028h	589	2,010	163033h	792	2,703	163040h	1,037	3,539
	858	163029h	815	2,782	163034h	1,096	3,741	163041h	1,436	4,901
	1042	163030h	997	3,403	163035h	1,340	4,573	163042h	1,756	5,993
	1272	163031h	1,223	4,174	163036h	1,644	5,611	163043h	2,155	7,355
	1456	-	-	-	163037h	1,888	6,444	-	-	-
	1870	-	-	-	163038h	2,436	8,314	-	-	-
750	444	-	-	-	-	-	-	163049h	877	2,993
	628	-	-	-	-	-	-	163050h	1,266	4,321
	858	-	-	-	163044h	1,337	4,563	163051h	1,753	5,983
	1042	-	-	-	163045h	1,635	5,580	163052h	2,143	7,314
	1272	-	-	-	163046h	2,006	6,846	163053h	2,630	8,976
	1456	-	-	-	163047h	2,303	7,860	-	-	-
	1870	-	-	-	163048h	2,972	10,143	-	-	-

Δ t50 is the UK's industry standard for heating outputs, which has an operating temperature of 75/65/20°C. If you have a low temperature heat source you may wish to consider Δ t40 or Δ t30 output (see your installer or system designer or download from www.stelrad.com).

For EN442 data, technical and installation information please visit our website: www.stelrad.com and search product downloads.

COLUMN HORIZONTAL COLOURED

COLUMN HORIZONTAL FLOOR MOUNTING BRACKETS



UIN 148137 White
(sold in pairs)

FLOOR MOUNTING BRACKET INFORMATION	
400 - 1500mm	2 feet

OPTIONAL FLOOR MOUNTING BRACKETS

All dimensions in mm. Inches in brackets.

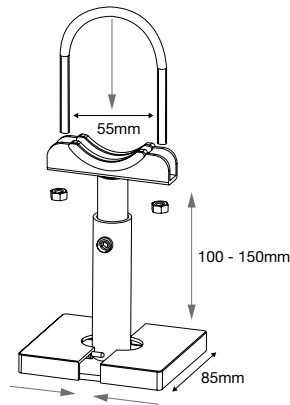
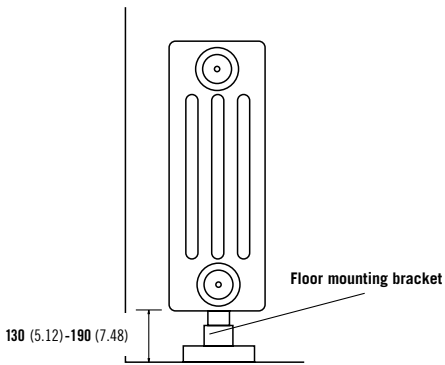

BRACKET INSTALLATION

All dimensions in mm. Inches in brackets.

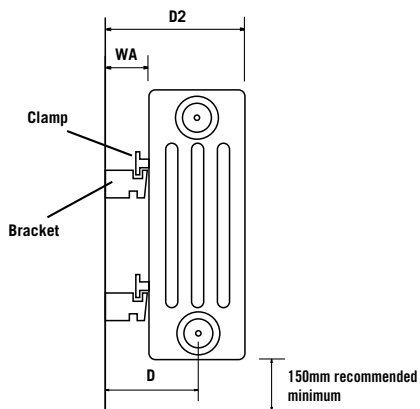

MEASUREMENTS USING 10mm CVD BRACKETS SLOT

Add 5mm if using 15mm slot

	WA	D	D2
2 Col	23	54	85
3 Col	23	73	123
4 Col	23	91	159

BRACKETS AND CLAMPS REQUIRED

	No of Sections
4	0 - 23
6	24 - 41

Number of columns	Wall to centre of connections		Wall to front face of radiator
	Using 10mm bracket slot	Using 15mm bracket slot	
2	54	59	85 or 90
3	73	78	123 or 128
4	91	96	159 or 164

All sizes (approximate) in mm

CONNECTIONS

Each radiator comes with ½" inlet connections as standard.

COLUMN HORIZONTAL COLOURED

VALVE INSTALLATION

All dimensions in mm. Inches in brackets.

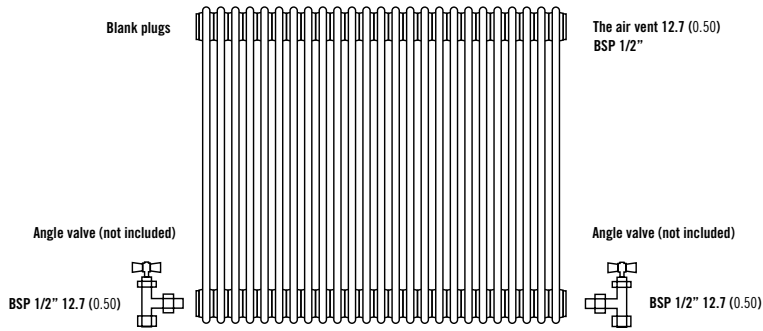

Note: Factory fitted bushes are welded in place and not removable.
If installing TBOE (Top Bottom Opposite End) please note that the radiator MUST be inverted.

EN 442 CERTIFICATION DATA - CETIAT TESTED IN ACCORDANCE WITH BS EN 442

Type	2 Columns		3 Columns			4 Columns
Height	500	600	300	500	600	600
W/m at 75/65/20	835	985	696	1122	1324	1734
n-coefficients	1.25	1.25	1.25	1.25	1.26	1.27
Heated surface area (m ² /m)	1.52	1.96	1.52	2.39	3.04	4.13
Weight (kg/m)	17.39	21.74	15.22	26.09	30.43	43.48
Water contents (l/m)	10.87	13.04	13.04	17.39	19.57	26.09
Wall to tap centre (mm)	54 / 59	54 / 59	73 / 78	73 / 78	73 / 78	91 / 96

PRESSURE DROPS

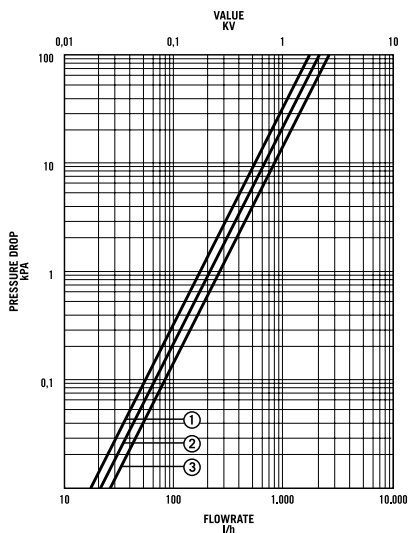

- ① 2 Column (P1), 11 (K1)
- ② 3 Column (P+), 22 (K2)
- ③ 4 Column (K3)

CONNECTIONS

Each radiator comes with 1/2" inlet connections as standard.

COLOUR GUIDE

RAL COLOURS



RAL 7035
Pale grey

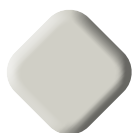

RAL 7038
Agate grey

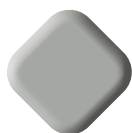

RAL 7036
Platinum grey

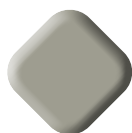

RAL 7030
Stone grey



RAL 7037
Dusty grey

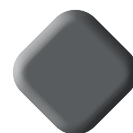

RAL 7015
Slate grey

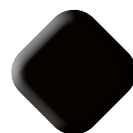

RAL 9005*
Jet black



RAL 8017
Chocolate brown

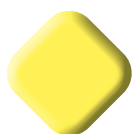

RAL 1016
Sulphur yellow



RAL 1021
Cadmium yellow



RAL 1004
Dark Golden yellow



RAL 2008
Light red orange



RAL 3000
Flame red



RAL 3003
Ruby red



RAL 3005
Wine red



RAL 6027
Light green

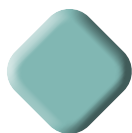

RAL 6034
Pastel turquoise

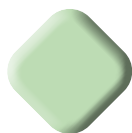

RAL 6019
Pastel green

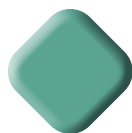

RAL 6033
Turquoise blue

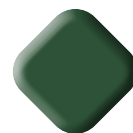

RAL 6020
Chrome green

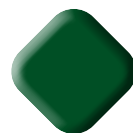

RAL 6005
Light moss green

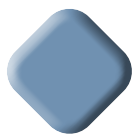

RAL 5014
Pigeon blue



RAL 5002
Ultramarine blue

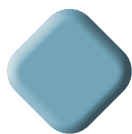

RAL 5024
Pastel blue



RAL 5022
Night blue



RAL 5010
Gentian blue



RAL 9016
Traffic white



RAL 9010
Pure white



RAL 9001
Cream



RAL 1013
Pearl white



RAL 1015
Light ivory



RAL 9002
Grey white

METALLIC COLOURS



N206 BR0006
Silver metallic

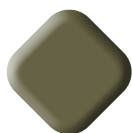

N204 BR0004
Bronze metallic

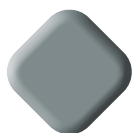

N206 BR0007
Grey metallic

To request up to 5 colour samples, please email sales@stelrad.com with your choices and address details.

The colours shown are reproduced as accurately as this printing process will allow.

FOR FURTHER INFORMATION ON RAL COLOURS PLEASE VISIT WWW.RALCOLORCHART.COM

 RAL 9016** Traffic white comes as standard on all radiators.

Stelrad Radiators are available in white (RAL 9016) as standard, however the specific Radiators identified are now available in a variety of colours. The colours shown are reproduced as accurately as this process will allow and can be made to order on the identified products.

All colour radiators have up to an 8 week lead time, and when a coloured radiator or radiators have been ordered they cannot be cancelled or returned.

To request a colour chart please email sales@stelrad.com