

HOME

SERIES



Ultra

ULTRA

50 Δ t
(75/65/20°C)

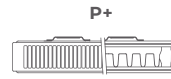

Front Panel Height mm	Emitter Height mm	Front Panel Length mm	Emitter Length mm	P+			K2		
				Stelrad UIN	Heat output Watts	Btu/h	Stelrad UIN	Heat output Watts	Btu/h
545	500	470	400	-	-	-	83512204h	522	1781
		670	600	-	-	-	83512206h	782	2668
		870	800	-	-	-	83512208h	1043	3559
		1070	1000	-	-	-	83512210h	1304	4449
		1270	1200	-	-	-	83512212h	1565	5340
		1470	1400	-	-	-	83512214h	1826	6231
		1670	1600	-	-	-	83512216h	2086	7118
		1870	1800	-	-	-	83512218h	2347	8008
		2070	2000	-	-	-	83512220h	2608	8899
645	600	470	400	83612104h	474	1616	83612204h	599	2044
		670	600	83612106h	710	2424	83612206h	899	3068
		870	800	83612108h	947	3232	83612208h	1198	4088
		1070	1000	83612110h	1184	4040	83612210h	1498	5111
		1270	1200	83612112h	1421	4848	83612212h	1798	6135
		1470	1400	83612114h	1658	5656	83612214h	2097	7155
		1670	1600	83612116h	1894	6464	83612216h	2397	8179
		1870	1800	83612118h	2131	7272	83612218h	2696	9199
		2070	2000	83612120h	2368	8080	83612220h	2996	10223

Δ t50 is the UK's industry standard for heating outputs, which has an operating temperature of 75/65/20°C. If you have a low temperature heat source you may wish to consider Δ t40 or Δ t30 output (see your installer or system designer or download from www.stelrad.com).

For EN442 data, technical and installation information please visit our website: www.stelrad.com and search product downloads.

ULTRA TOWEL RAIL BAR



Fits emitter length	Stelrad UIN
400mm wide	83100004
600mm wide	83100006
800mm wide	83100008
1000mm wide	83100010

Towel rail bar is 120mm wider than actual radiator.
Maximum two towel rail bars per radiator.
For more information visit www.stelrad.com



Comes with a 2 year warranty.

ULTRA

WALL MOUNTING AND LUG INFORMATION

All dimensions in mm. Inches in brackets.

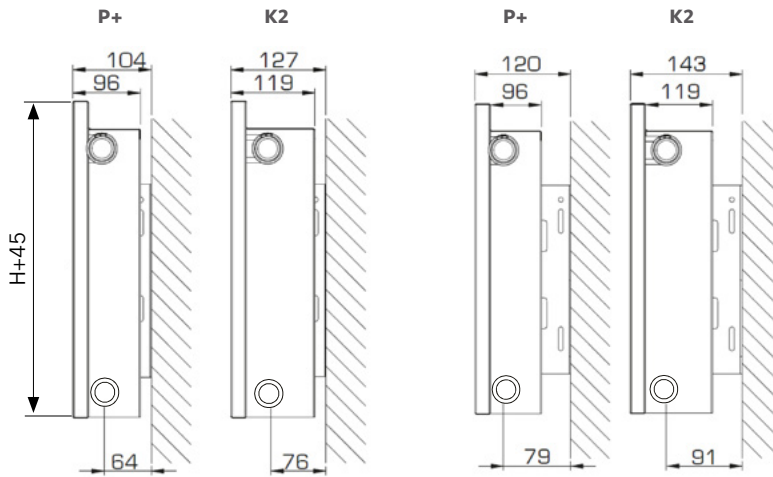

Mounting on short side of L-bracket

Mounting on long side of L-bracket

MOUNTING BRACKETS

All dimensions in mm. Inches in brackets.

Floor mounting brackets available.

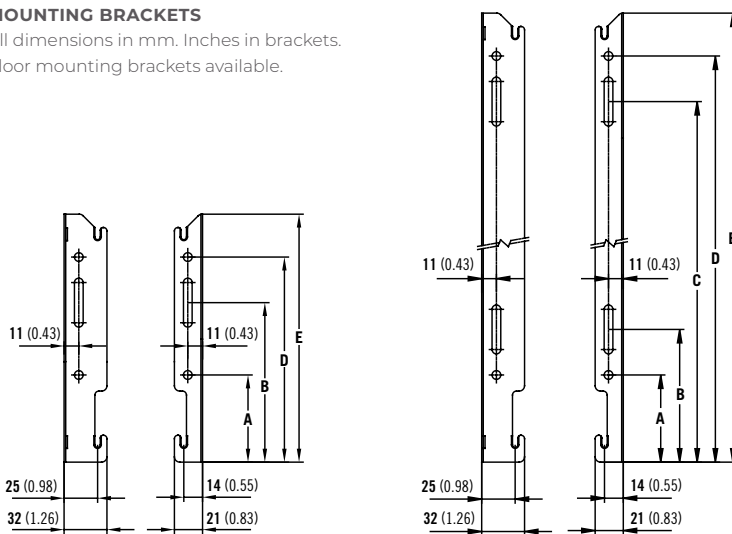

P+ and K2
(300mm)

P+ and K2
(OVER 300mm)

P+ AND K2 (300mm)

Dimensions	mm	inches	mm	inches	mm	inches	mm	inches
Height	300	11.81	450	17.72	600	23.62	700	27.56
A	65	2.56	65	2.56	65	2.56	65	2.56
B	119	4.69	99	3.90	99	3.90	99	3.90
C	-	-	269	10.59	419	16.50	519	20.43
D	153	6.02	303	11.93	453	17.83	553	21.77
E	185	7.28	335	13.19	485	19.09	585	23.03

ULTRA

P+ AND K2 LUGS POSITIONS

All dimensions in mm. Inches in brackets.

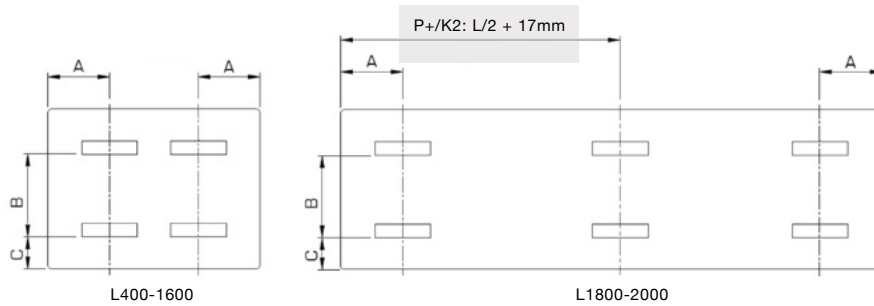

Length	A	H	B	C
	P+/K2			
1200 - 1600	133	-	-	-
500 - 1100mm	133	500	305	60
1200 - 1600	133	600	455	60
1800 - 2000	133	-	-	-

Above positions are with respect to the edge of the emitter, not the front panel.

CONNECTIONS

Each radiator comes with 1/2" inlet connections as standard.

EN 442 CERTIFICATION DATA - CETIAT TESTED IN ACCORDANCE WITH BS EN 442

Type	P+	K2	K2
Height	600	500	600
W/m at 75/65/20	1184	1304	1498
n-coefficients	1.31	1.29	1.30
Heated surface area (m ² /m)	5.24	6.33	7.74
Weight (kg/m)	34.80	32.73	38.80
Water contents (l/m)	6.80	5.83	6.90

COLOUR GUIDE

NATURAL COLOURS



NT110
Papyrus white



NT120
Pearl white



NT130
Champagne



NT140
Beige

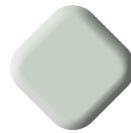

NT150
Beige grey

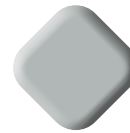

NT160
Pebble grey

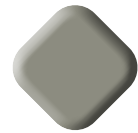

NT170
Quartz grey



SN110
Cream white



SN120
Cream

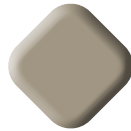

SN130
Mocca



SN140
Bordeaux

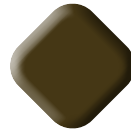

SN150
Sepia

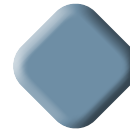

SN160
Pale blue

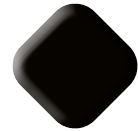

SN170
Black

METALLIC COLOURS



ML110
Dove grey

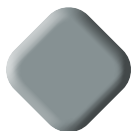

ML120
Titanium grey

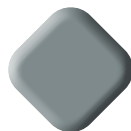

ML130
Blue grey

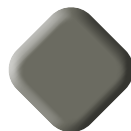

ML140
Granite

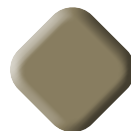

ML150
Cappuccino

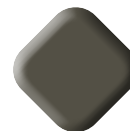

ML160
Terra brown

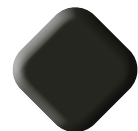

ML170
Graphite black

RAL COLOURS



A1004
Golden yellow



A2003
Pastel orange



A3002
Carmine red



A3003
Robin red



A5002
Ultramarine blue

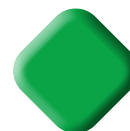

A6018
Yellow green



A7001
Silver grey

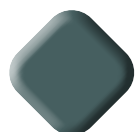

A7011
Iron grey

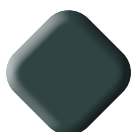

A7016
Anthracite grey



A7030
Stone grey



A7035
Light grey



A8017
Chocolate brown



A9003
Signal white

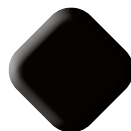

A9005
Jet black

To request up to
5 colour samples, please
email sales@stelrad.com
with your choices and
address details.

The colours shown are reproduced
as accurately as this printing
process will allow.

FOR FURTHER INFORMATION ON RAL COLOURS PLEASE VISIT WWW.RALCOLORCHART.COM



RAL 9016**
Traffic white
comes as
standard on
all radiators.

Stelrad Radiators are available in white (RAL 9016) as standard, however the specific Radiators identified are now available in a variety of colours. The colours shown are reproduced as accurately as this process will allow and can be made to order on the identified products.

All colour radiators have up to an 8 week lead time, and when a coloured radiator or radiators have been ordered they cannot be cancelled or returned.

To request a colour chart please email
sales@stelrad.com